

Extreme Power DomiLED

With its significant power in terms brightness, viewing angle and variety of application possibilities, Extreme Power DomiLED truly is a standout performer! Ideal for automotive interior lighting as well as home, office and industrial applications, it is also a proven performer in electronic signs and signals.

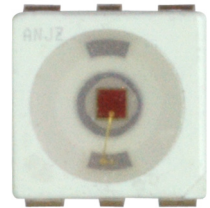

Features:

- > High brightness surface mount LED using thin film technology.
- > 115° viewing angle.
- > Low thermal resistance.
- > Qualified according to JEDEC moisture sensitivity Level 2.
- > Compatible to IR reflow soldering.
- > Environmental friendly; RoHS compliance.
- > Compliance to automotive standard; AEC-Q101.
- > Superior Corrosion Resistance.



Applications:

- > Automotive: interior applications, eg: switches, telematics, climate control system, dashboard, etc.
- > Automotive: exterior applications, eg: signal lighting, Center High Mounted Stop Light (CHMSL), Rear Combination Light (RCL).



Optical Characteristics at Tj=25°C

Part Ordering Number	Color	Viewing Angle°	Luminous Flux @ IF = 140mA(lm) <i>Appx. 1.2</i>		
			Min.	Typ.	Max.
D6S-SKG-K3N2-1	Super Red, 632nm	115	9.35	13.9	20.6
D6A-SKG-M3Q2-1	Amber, 617nm	115	15.8	23.5	34.8
D6Y-SKG-L3P2-1	Yellow, 589nm	115	12.2	18.1	26.8

Electrical Characteristics at Tj=25°C

Part Number	Vf @ If = 140mA <i>Appx. 3.1</i>			Vr @ Ir = 10uA
	Min. (V)	Typ. (V)	Max. (V)	Min. (V)
D6x-SKG	1.90	2.30	2.50	12

Absolute Maximum Ratings

	Maximum Value	Unit
DC forward current	200	mA
Peak pulse current; (tp ≤ 10µs, Duty cycle = 0.1)	300	mA
Reverse voltage	12	V
ESD threshold (HBM)	2	kV
LED junction temperature	125	°C
Operating temperature	-40 ... +115	°C
Storage temperature	-40 ... +125	°C
Thermal resistance		
- Real Thermal Resistance		
Junction / ambient, R _{th JA real}	110	K/W
Junction / solder point, R _{th JS real}	60	K/W
- Electrical Thermal Resistance		
Junction / ambient, R _{th JA el}	100	K/W
Junction / solder point, R _{th JS el}	40	K/W
(Mounting on FR4 PCB, pad size ≥ 16 mm ² per pad)		

Wavelength Grouping at Tj= 25°C

Color	Group	Wavelength distribution (nm) <i>Appx. 2.2</i>
D6S, Super Red	Full	627 - 639
D6A; Amber	Full	612 - 624
	W	612 - 616
	X	616 - 620
	Y	620 - 624
D6Y; Yellow	Full	586 - 595
	X	586 - 589
	Y	589 - 592
	Z	592 - 595

Luminous Flux Group

Brightness Group	Luminous Flux <i>Appx. 1.2</i> (lm)
K3	9.35 ... 10.7
L2	10.7 ... 12.2
L3	12.2 ... 13.9
M2	13.9 ... 15.8
M3	15.8 ... 18.1
N2	18.1 ... 20.6
N3	20.6 ... 23.5
P2	23.5 ... 26.8
P3	26.8 ... 30.6
Q2	30.6 ... 34.8

Vf Bining (Optional)

Vf @ If = 140mA	Forward Voltage (V) <small>Appx. 3.1</small>
V1	1.90 ... 2.05
V2	2.05 ... 2.20
V3	2.20 ... 2.35
V4	2.35 ... 2.50

Please consult sales and marketing for special part number to incorporate Vf binning.

Relative Luminous Flux Vs Forward Current

$\Phi_v / \Phi_v(140\text{mA}) = f(I_F); T_j = 25^\circ\text{C}$

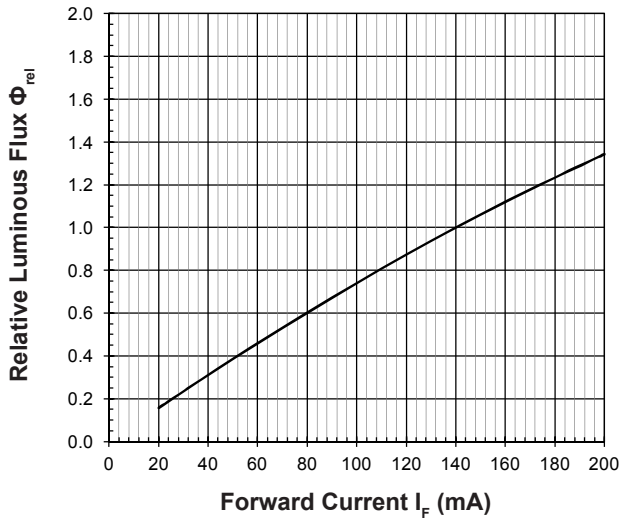

Forward Current Vs Forward Voltage

$I_F = f(V_F); T_j = 25^\circ\text{C}$

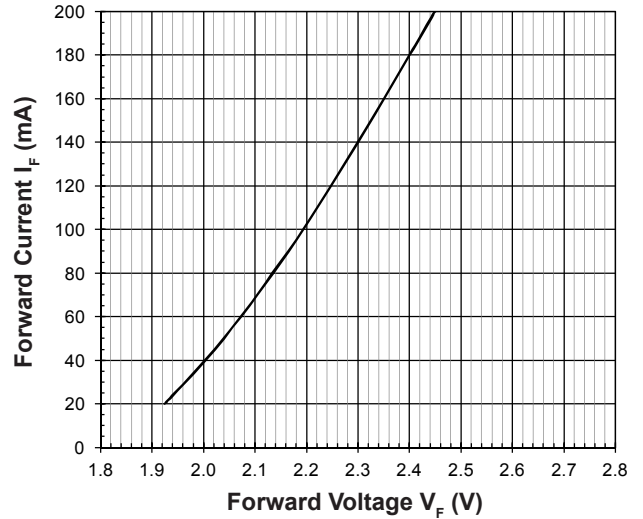

Maximum Current Vs Temperature

$I_F = f(T)$

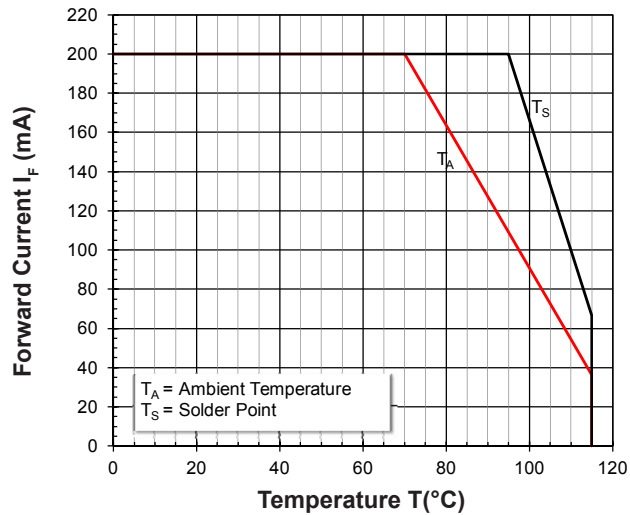

Relative Spectral Emission

$\Phi_{rel} = f(\lambda); T_j = 25^\circ\text{C}; I_F = 140\text{mA}$

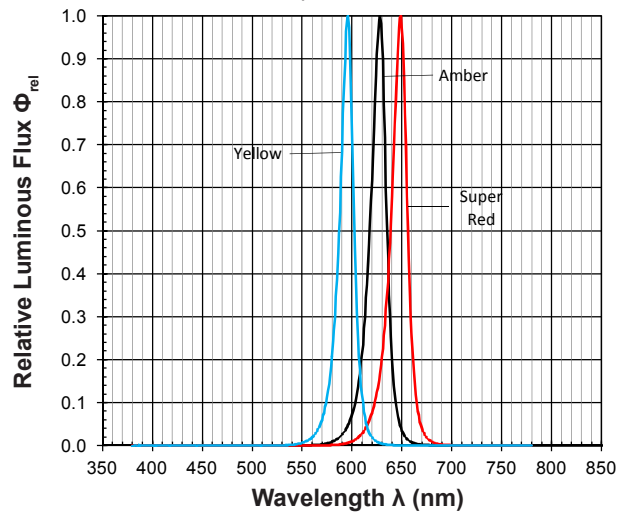

Allowable Forward Current Vs Duty Ratio

$(T_j = 25^\circ\text{C}; t_p \leq 10\mu\text{s})$

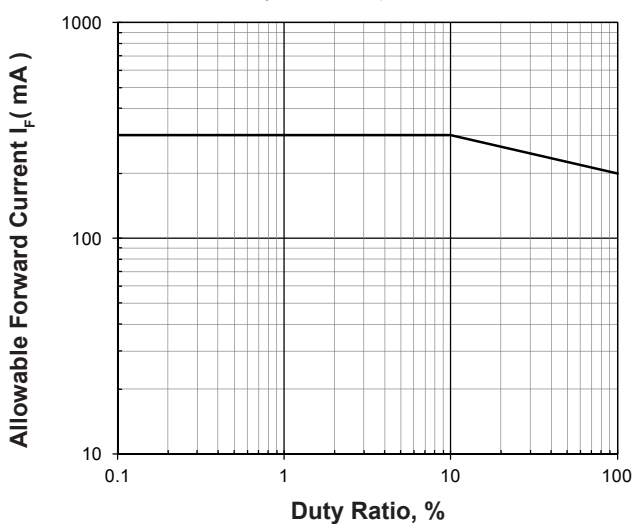

Radiation Pattern

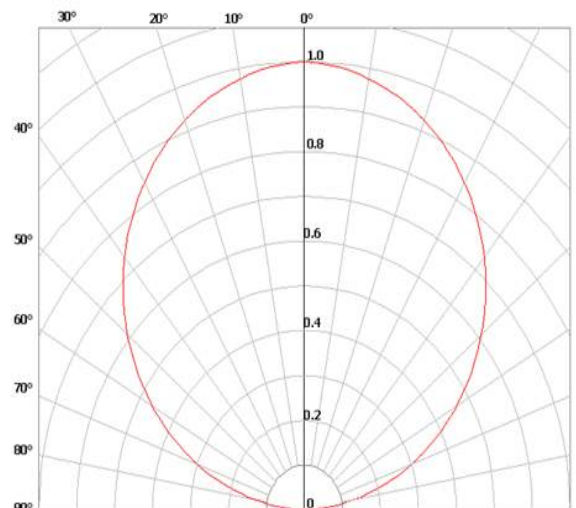

Relative Forward Voltage Vs Junction Temperature

$\Delta V_F = V_F - V_F(25^\circ\text{C}) = f(T_j); I_F = 140\text{mA}$

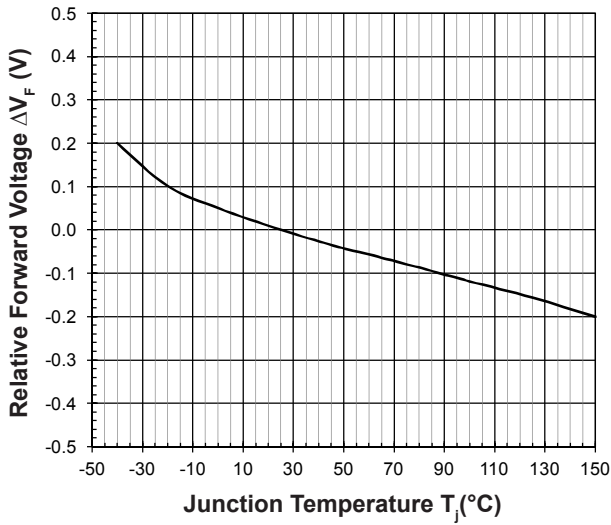

Relative Luminous Flux Vs Junction Temperature

$\Phi_V/\Phi_V(25^\circ\text{C}) = f(T_j); I_F = 140\text{mA}$

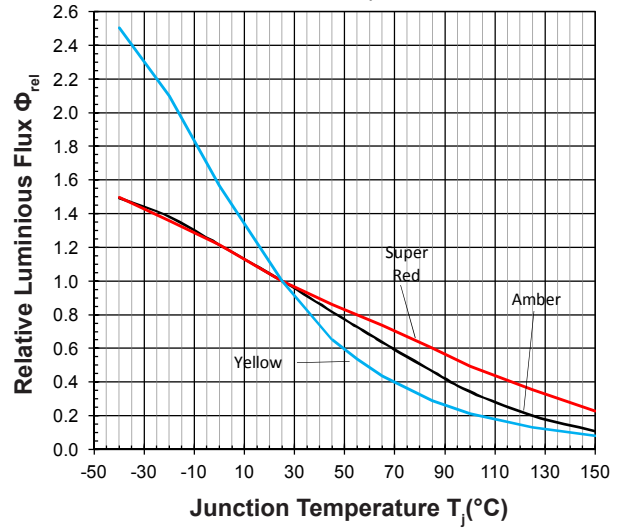

Relative Wavelength Vs Junction Temperature

$\Delta \lambda_{dom} = \lambda_{dom} - \lambda_{dom}(25^\circ\text{C}) = f(T_j); I_F = 140\text{mA}$

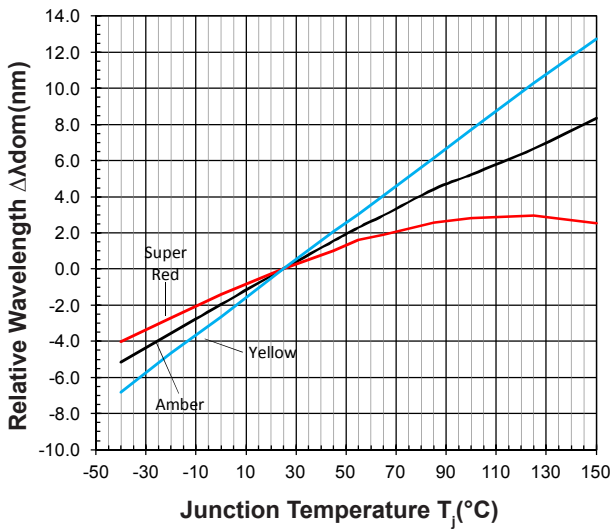

Extreme Power DomiLED • AllnGaP : D6x-SKG Package Outlines

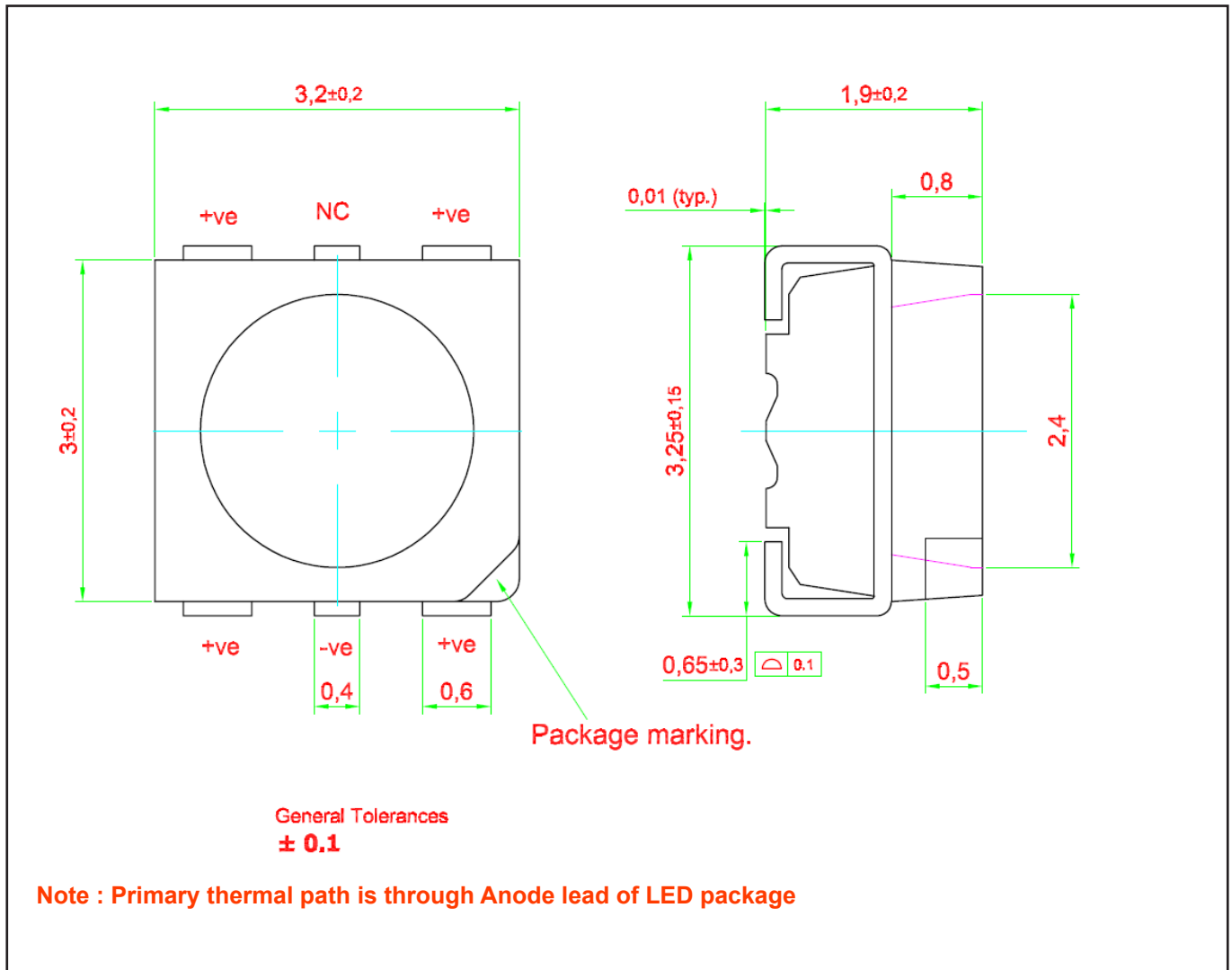

Material

	Material
Lead-frame	Cu Alloy With Au Plating
Package	High Temperature Resistant Plastic, PPA
Encapsulant	Silicone
Soldering Leads	Au Plating

Recommended Solder Pad

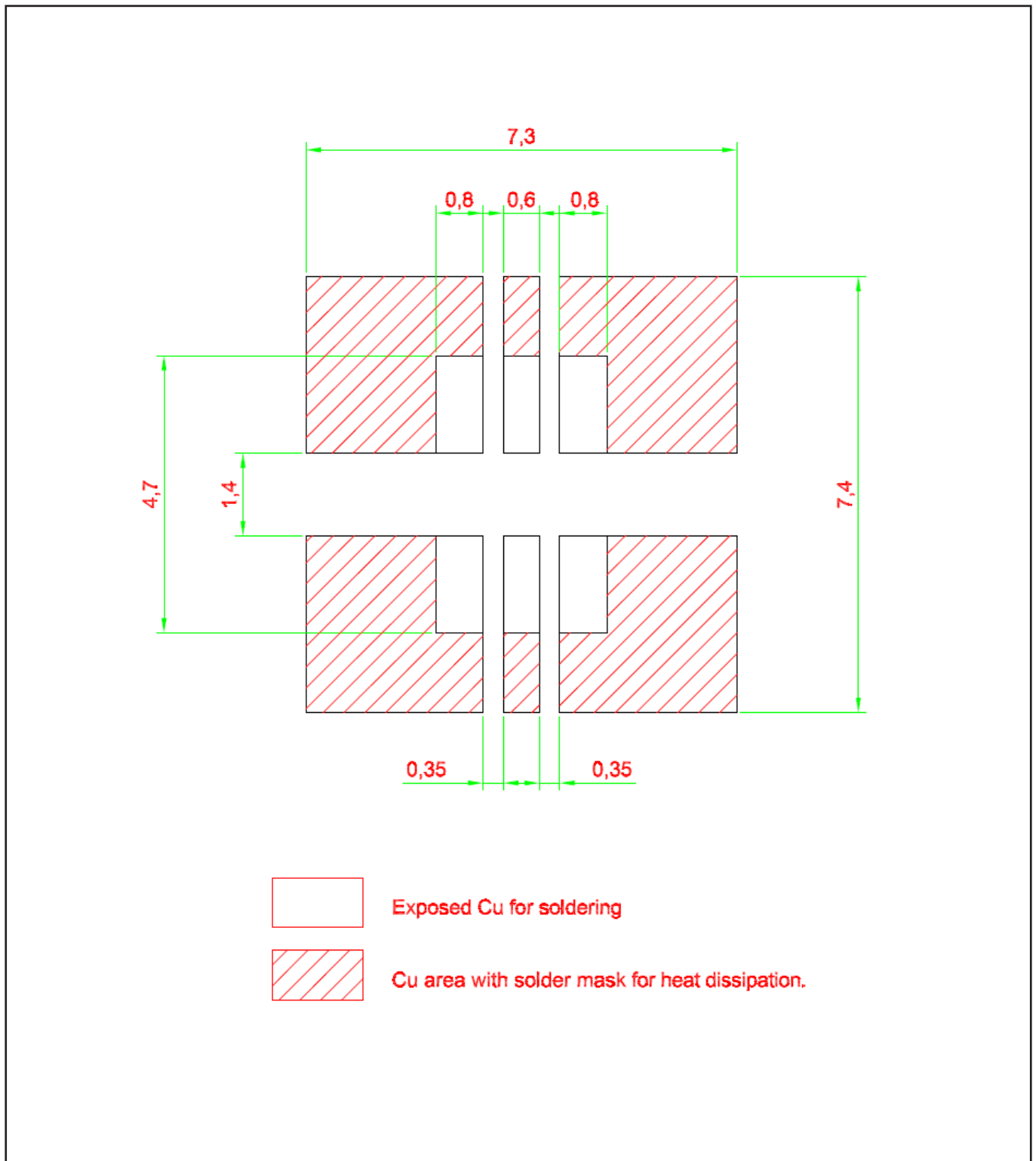

Taping and orientation

- Reels come in quantity of 1000 units.
- Reel diameter is 180 mm.

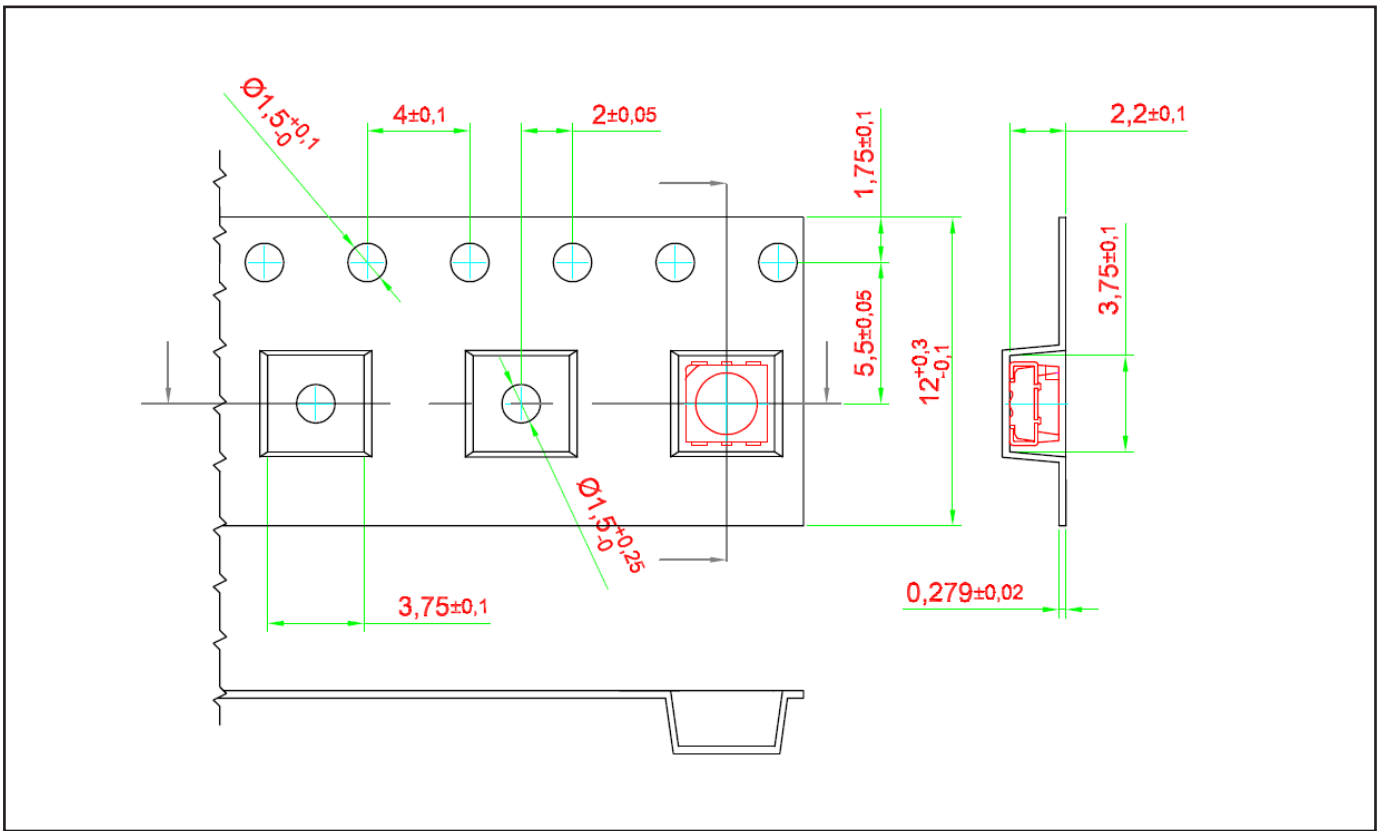

Packaging Specification

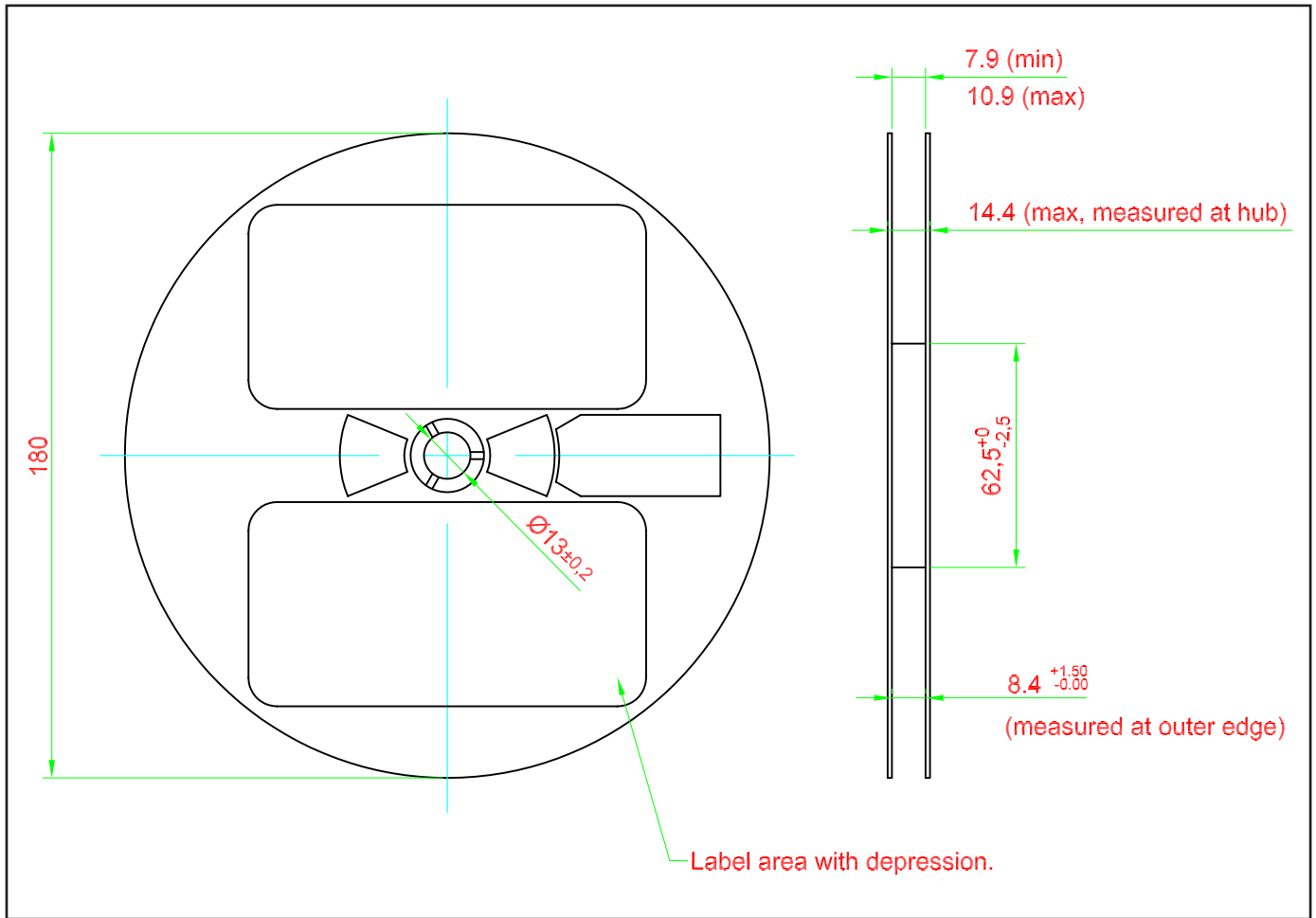

Packaging Specification

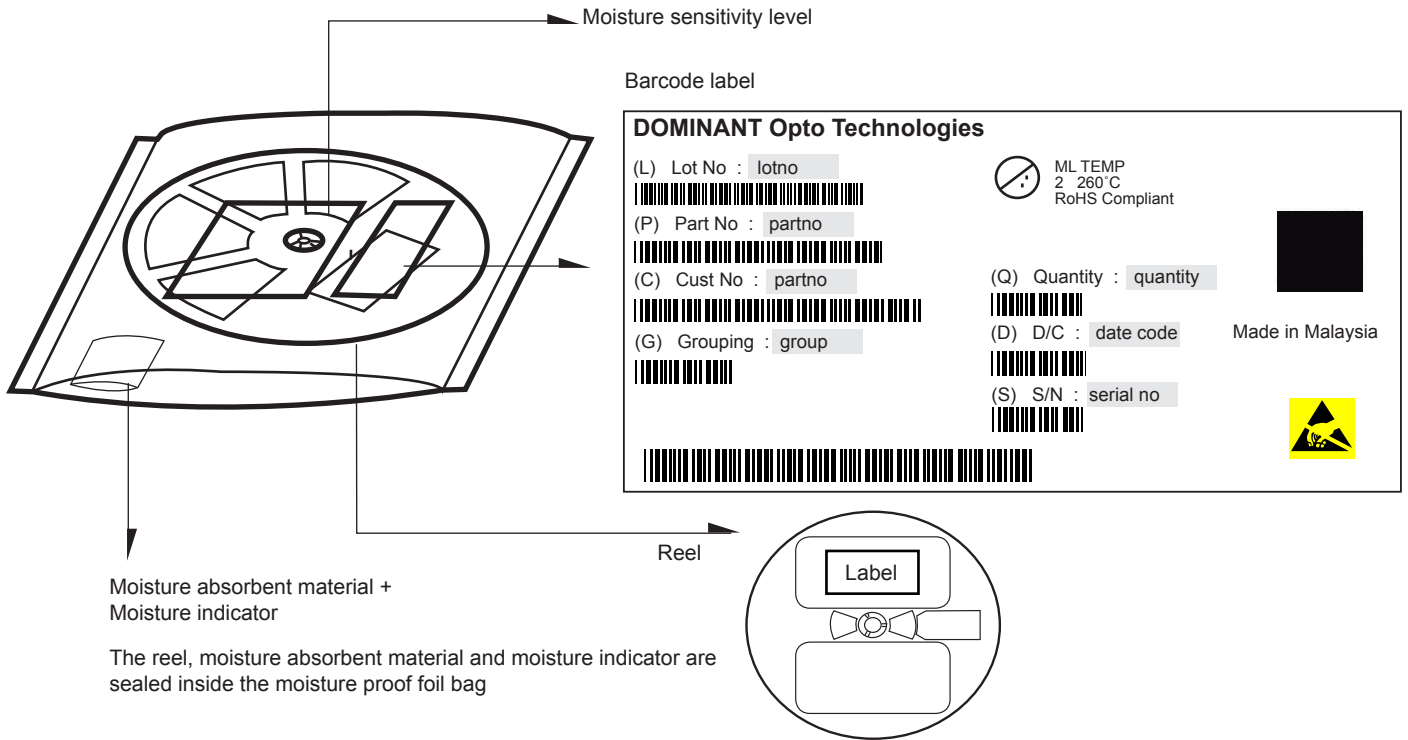

Average 1pc Extreme Power DomiLED	1 completed bag (1000pcs)
Weight (gram)	0.036
	240 ± 10

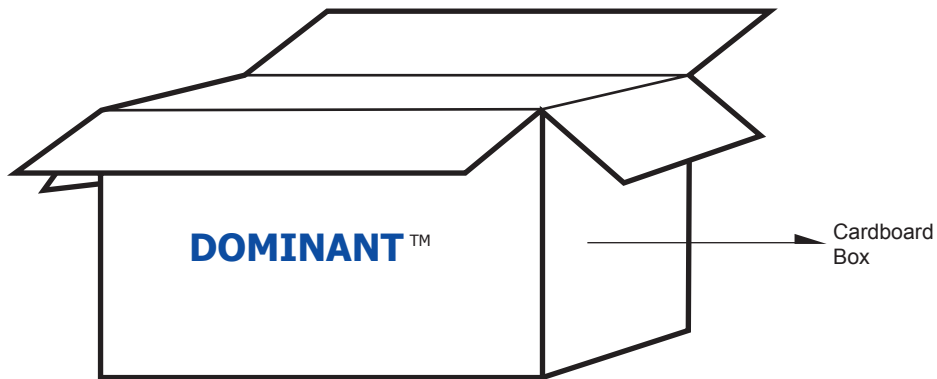

For Extreme Power DomiLED

Cardboard Box Size	Dimensions (mm)	Empty Box Weight (kg)	Reel / Box
Super Small	325 x 225 x 190	0.38	7 reels MAX
Small	325 x 225 x 280	0.54	11 reels MAX
Medium	570 x 440 x 230	1.46	48 reels MAX
Large	570 x 440 x 460	1.92	96 reels MAX

Recommended Pb-free Soldering Profile

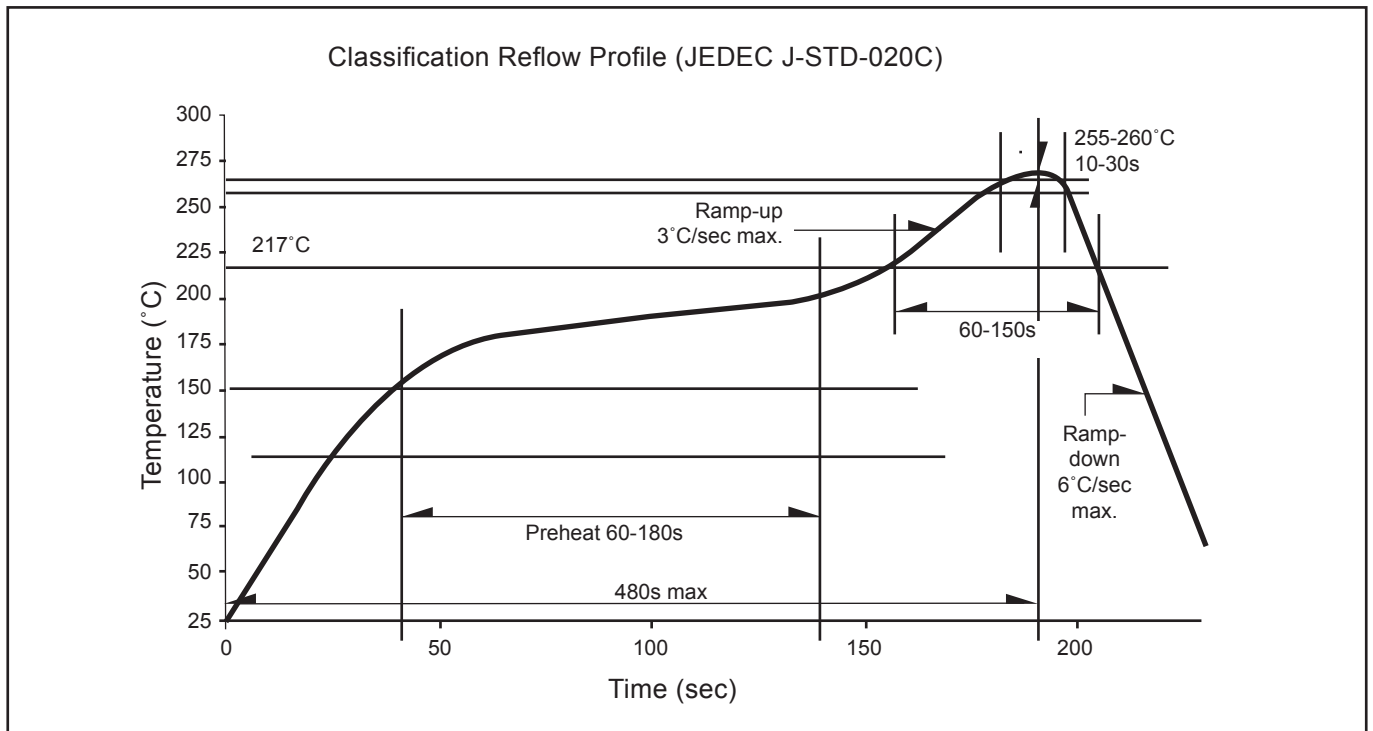

Appendix

1) **Brightness:**

- 1.1 Luminous intensity is measured with an internal reproducibility of $\pm 8 \%$ and an expanded uncertainty of $\pm 11 \%$ (according to GUM with a coverage factor of $k=3$).
- 1.2 Luminous flux is measured with an internal reproducibility of $\pm 8 \%$ and an expanded uncertainty of $\pm 11 \%$ (according to GUM with a coverage factor of $k=3$).

2) **Color:**

- 2.1 Chromaticity coordinate groups are measured with an internal reproducibility of ± 0.005 and an expanded uncertainty of ± 0.01 (accordingly to GUM with a coverage factor of $k=3$).
- 2.2 DOMINANT wavelength is measured with an internal reproducibility of $\pm 0.5\text{nm}$ and an expanded uncertainty of $\pm 1\text{nm}$ (accordingly to GUM with a coverage factor of $k=3$).

3) **Voltage:**

- 3.1 Forward Voltage, V_f is measured with an internal reproducibility of $\pm 0.05\text{V}$ and an expanded uncertainty of $\pm 0.1\text{V}$ (accordingly to GUM with a coverage factor of $k=3$).

Revision History

Page	Subjects	Date of Modification
-	Initial Release	03 Nov 2016
3	Update Wavelength Grouping for Super Red	14 Aug 2017

NOTE

All the information contained in this document is considered to be reliable at the time of publishing. However, DOMINANT Opto Technologies does not assume any liability arising out of the application or use of any product described herein.

DOMINANT Opto Technologies reserves the right to make changes to any products in order to improve reliability, function or design.

DOMINANT Opto Technologies products are not authorized for use as critical components in life support devices or systems without the express written approval from the Managing Director of DOMINANT Opto Technologies.

About Us

DOMINANT Opto Technologies is a dynamic company that is amongst the world's leading automotive LED manufacturers. With an extensive industry experience and relentless pursuit of innovation, DOMINANT's state-of-art manufacturing and development capabilities have become a trusted and reliable brand across the globe. More information about DOMINANT Opto Technologies, a ISO/TS 16949 and ISO 14001 certified company, can be found under <http://www.dominant-semi.com>.

Please contact us for more information:

DOMINANT Opto Technologies Sdn. Bhd
Lot 6, Batu Berendam, FTZ Phase III, 75350 Melaka, Malaysia.
Tel: +606 283 3566 Fax: +606 283 0566
E-mail: sales@dominant-semi.com
