

Mini DomiLED

With the intense colors that seem to glow with energy and its significant brightness, Mini DomiLED white LED is a highly reliable design device. Its dynamic nature makes it perfect choice for lighthing applications, office and home applications and standard industrial applications.



Features:

- > High brightness surface mount LED.
- > Based on InGaN technology.
- > 120° viewing angle.
- > Small package outline (LxWxH) of 2.0 x 1.4 x 1.3mm.
- > Qualified according to JEDEC moisture sensitivity Level 2.
- > Compatible to both IR reflow soldering.
- > Environmental friendly; RoHS compliance.
- > Passed corrosion resistance test. *Appx. 7.1*
- > Compliance to AEC-Q102 Standard.



Applications:

- > Automotive: interior applications, eg: switches, telematics, climate control system, dashboard, etc.
- > Backlighting: button, LCD display

Optical Characteristics at Tj=25°C

Part Number	Color	Viewing Angle°	Luminous Intensity @ IF = 20mA IV (mcd) <i>Appx. 1.1</i>		
			Min.	Typ.	Max.
DNW-PJG-V2W-F1H3	White	120	900.0	1400.0	1800.0
DNW-PJG-V2W-I1L3	White	120	900.0	1400.0	1800.0
DNW-PJG-WX1-M1P3	White	120	1125.0	1800.0	2240.0
● DNW-PJG-V2W-F1H5	White	120	900.0	1400.0	1800.0
● DNW-PJG-V2W-I1L5	White	120	900.0	1400.0	1800.0
● DNW-PJG-WX1-M1P5	White	120	1125.0	1800.0	2240.0
● DNW-PJG-VW1-F1H5	White	120	715.0	1125.0	1400.0
● DNW-PJG-V2W-M1P5	White	120	900.0	1400.0	1800.0

● Not for new design.

Electrical Characteristics at Tj=25°C

Part Number	Vf @ If = 20 mA <i>Appx. 3.1</i>			Vr @ Ir = 10 µA
	Min. (V)	Typ. (V)	Max. (V)	Min. (V)
DNW-PJG	2.8	3.1	3.3	5.0

Absolute Maximum Ratings

	Maximum Value	Unit
DC forward current	20	mA
Peak pulse current; (tp ≤ 10µs, Duty cycle = 0.005)	200	mA
Reverse voltage <i>Appx. 6.1</i>	5	V
ESD threshold (HBM)	2000	V
LED junction temperature	125	°C
Operating temperature	-40 ... +100	°C
Storage temperature	-40 ... +100	°C
Power dissipation (at room temperature)	85	mW
Thermal resistance		
- Junction / ambient, R _{th JA}	480	K/W
- Junction / solder point, R _{th JS}	230	K/W

DNW, Color Grouping *Appx. 2.1*

*Color Bin F4P5 Not For New Design

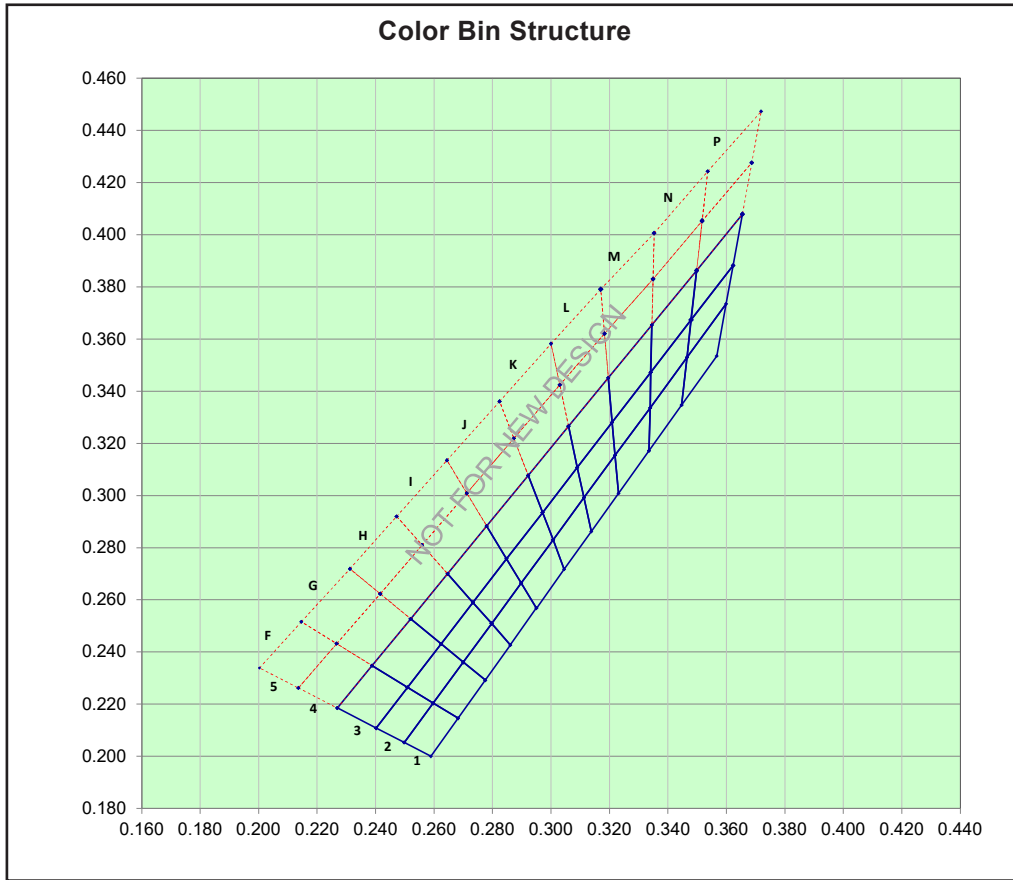

Bin		1	2	3	4
F1	Cx	0.2498	0.2589	0.2682	0.2597
	Cy	0.2053	0.2000	0.2146	0.2204
F2	Cx	0.2402	0.2498	0.2597	0.2509
	Cy	0.2108	0.2053	0.2204	0.2264
F3	Cx	0.2269	0.2388	0.2509	0.2402
	Cy	0.2185	0.2348	0.2264	0.2108
F4	Cx	0.2136	0.2267	0.2388	0.2269
	Cy	0.2262	0.2432	0.2348	0.2185
F5	Cx	0.2003	0.2146	0.2267	0.2136
	Cy	0.2339	0.2516	0.2432	0.2262
G1	Cx	0.2597	0.2682	0.2775	0.2700
	Cy	0.2204	0.2146	0.2292	0.2361
G2	Cx	0.2509	0.2597	0.2700	0.2624
	Cy	0.2264	0.2204	0.2361	0.2431
G3	Cx	0.2388	0.2509	0.2624	0.2520
	Cy	0.2348	0.2264	0.2431	0.2527
G4	Cx	0.2267	0.2416	0.2520	0.2388
	Cy	0.2432	0.2623	0.2527	0.2348
G5	Cx	0.2146	0.2312	0.2416	0.2267
	Cy	0.2516	0.2719	0.2623	0.2432

Bin		1	2	3	4
H1	Cx	0.2700	0.2775	0.2861	0.2797
	Cy	0.2361	0.2292	0.2427	0.2509
H2	Cx	0.2624	0.2700	0.2797	0.2733
	Cy	0.2431	0.2361	0.2509	0.2590
H3	Cx	0.2520	0.2624	0.2733	0.2646
	Cy	0.2527	0.2431	0.2590	0.2700
H4	Cx	0.2416	0.2559	0.2646	0.2520
	Cy	0.2623	0.2810	0.2700	0.2527
H5	Cx	0.2312	0.2472	0.2559	0.2416
	Cy	0.2719	0.2920	0.2810	0.2623
I1	Cx	0.2797	0.2861	0.2950	0.2898
	Cy	0.2509	0.2427	0.2568	0.2664
I2	Cx	0.2733	0.2797	0.2898	0.2848
	Cy	0.2590	0.2509	0.2664	0.2757
I3	Cx	0.2646	0.2733	0.2848	0.2780
	Cy	0.2700	0.2590	0.2757	0.2883
I4	Cx	0.2559	0.2712	0.2780	0.2646
	Cy	0.2810	0.3009	0.2883	0.2700
I5	Cx	0.2472	0.2644	0.2712	0.2559
	Cy	0.2920	0.3135	0.3009	0.2810
J1	Cx	0.2898	0.2950	0.3045	0.3007
	Cy	0.2664	0.2568	0.2717	0.2830
J2	Cx	0.2848	0.2898	0.3007	0.2971
	Cy	0.2757	0.2664	0.2830	0.2935
J3	Cx	0.2780	0.2848	0.2971	0.2922
	Cy	0.2883	0.2757	0.2935	0.3077
J4	Cx	0.2712	0.2873	0.2922	0.2780
	Cy	0.3009	0.3219	0.3077	0.2883
J5	Cx	0.2644	0.2824	0.2873	0.2712
	Cy	0.3135	0.3361	0.3219	0.3009
K1	Cx	0.3007	0.3045	0.3138	0.3113
	Cy	0.2830	0.2717	0.2862	0.2992
K2	Cx	0.2971	0.3007	0.3113	0.3090
	Cy	0.2935	0.2830	0.2992	0.3108
K3	Cx	0.2922	0.2971	0.3090	0.3060
	Cy	0.3077	0.2935	0.3108	0.3266
K4	Cx	0.2873	0.3030	0.3060	0.2922
	Cy	0.3219	0.3424	0.3266	0.3077
K5	Cx	0.2824	0.3000	0.3030	0.2873
	Cy	0.3361	0.3582	0.3424	0.3219
L1	Cx	0.3113	0.3138	0.3231	0.3219
	Cy	0.2992	0.2862	0.3008	0.3154
L2	Cx	0.3090	0.3113	0.3219	0.3209
	Cy	0.3108	0.2992	0.3154	0.3281
L3	Cx	0.3060	0.3090	0.3209	0.3196
	Cy	0.3266	0.3108	0.3281	0.3451
L4	Cx	0.3030	0.3183	0.3196	0.3060
	Cy	0.3424	0.3621	0.3451	0.3266
L5	Cx	0.3000	0.3170	0.3183	0.3030
	Cy	0.3582	0.3791	0.3621	0.3424

Bin		1	2	3	4
M1	Cx	0.3219	0.3231	0.3335	0.3339
	Cy	0.3154	0.3008	0.3172	0.3336
M2	Cx	0.3209	0.3219	0.3339	0.3341
	Cy	0.3281	0.3154	0.3336	0.3472
M3	Cx	0.3196	0.3209	0.3341	0.3345
	Cy	0.3451	0.3281	0.3472	0.3654
M4	Cx	0.3183	0.3349	0.3345	0.3196
	Cy	0.3621	0.3830	0.3654	0.3451
M5	Cx	0.3170	0.3353	0.3349	0.3183
	Cy	0.3791	0.4006	0.3830	0.3621
N1	Cx	0.3335	0.3339	0.3465	0.3447
	Cy	0.3172	0.3336	0.3530	0.3347
N2	Cx	0.3339	0.3341	0.3479	0.3465
	Cy	0.3336	0.3472	0.3673	0.3530
N3	Cx	0.3341	0.3345	0.3498	0.3479
	Cy	0.3472	0.3654	0.3863	0.3673
N4	Cx	0.3349	0.3517	0.3498	0.3345
	Cy	0.3830	0.4053	0.3863	0.3654
N5	Cx	0.3353	0.3536	0.3517	0.3349
	Cy	0.4006	0.4243	0.4053	0.3830
P1	Cx	0.3447	0.3465	0.3599	0.3567
	Cy	0.3347	0.3530	0.3735	0.3535
P2	Cx	0.3465	0.3479	0.3623	0.3599
	Cy	0.3530	0.3673	0.3882	0.3735
P3	Cx	0.3479	0.3498	0.3655	0.3623
	Cy	0.3673	0.3863	0.4079	0.3882
P4	Cx	0.3517	0.3687	0.3655	0.3498
	Cy	0.4053	0.4276	0.4079	0.3863
P5	Cx	0.3536	0.3719	0.3687	0.3517
	Cy	0.4243	0.4473	0.4276	0.4053

InGaN wavelength is very sensitive to drive current. Operating at lower current is not recommended and may yield unpredictable performance. Current pulsing should be used for dimming purposes.

Luminous Intensity Group at Tj=25°C

Brightness Group	Luminous Intensity <small>Appx. 1.1</small> IV (mcd)
V1	715.0 ... 900.0
V2	900.0 ... 1125.0
W1	1125.0 ... 1400.0
W2	1400.0 ... 1800.0
X1	1800.0 ... 2240.0

Vf Bining (Optional)

Vf @ If = 20mA	Forward Voltage (V) <small>Appx. 3.1</small>
V1	2.75 ... 3.05
V2	3.05 ... 3.35

Please consult sales and marketing for special part number to incorporate Vf binning.

Relative Luminous Intensity Vs Forward Current

$I_v/I_v(20\text{mA}) = f(I_F); T_j = 25^\circ\text{C}$

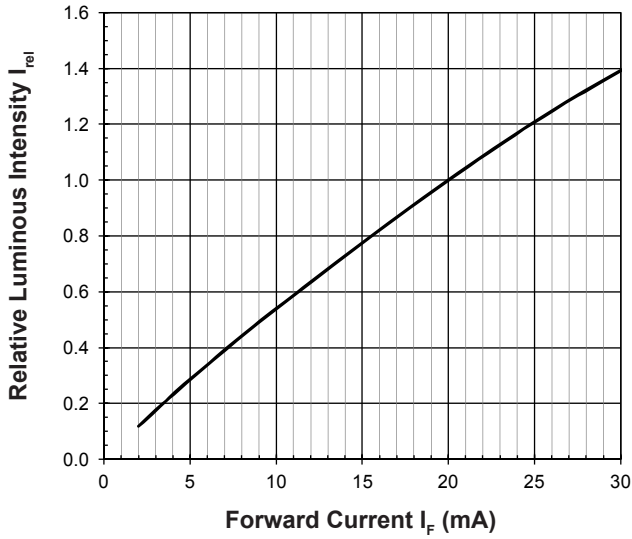

Forward Current Vs Forward Voltage

$I_F = f(V_F); T_j = 25^\circ\text{C}$

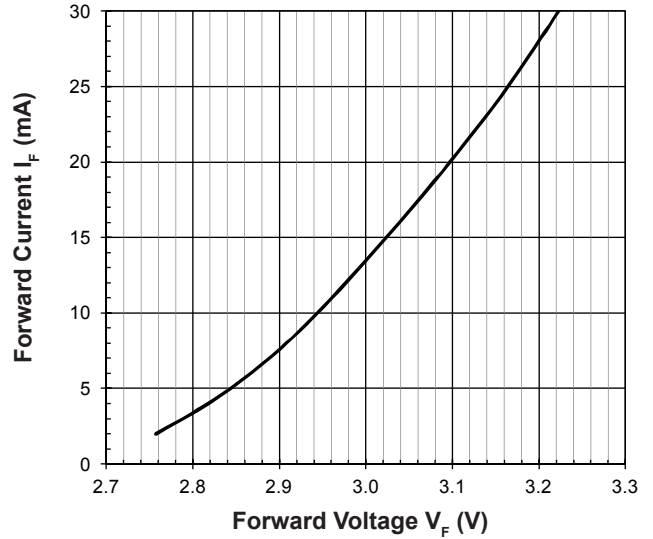

Maximum Current Vs Temperature

$I_F = f(T)$

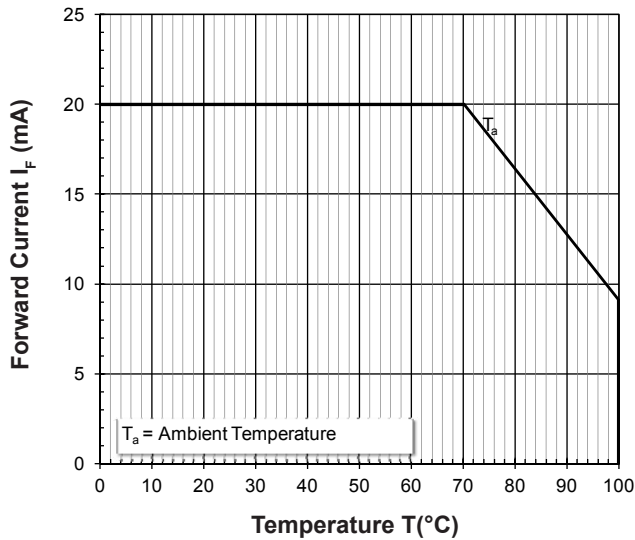

Relative Spectral Emission

$I_{rel} = f(\lambda); T_j = 25^\circ\text{C}; I_F = 20\text{mA}$

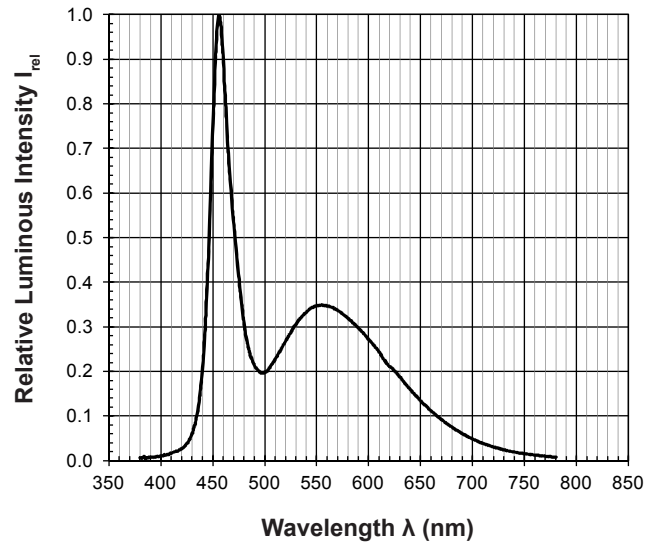

Chromaticity Coordinate Shift Vs Forward Current

$\Delta Cx, \Delta Cy = f(I_F); T_j = 25^\circ\text{C}$

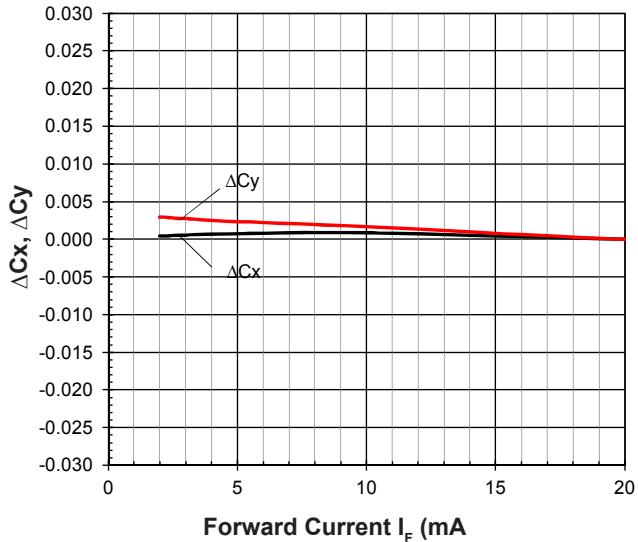

Allowable Forward Current Vs Duty Ratio

$(T_s = 55^\circ\text{C}; t_p \leq 100\mu\text{s})$



Radiation Pattern

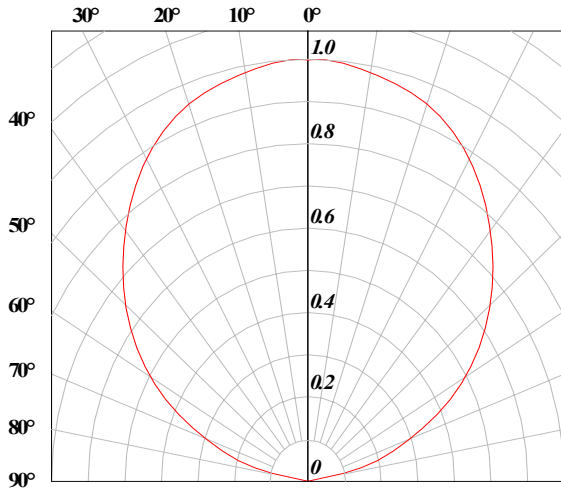

Forward Voltage Vs Junction Temperature

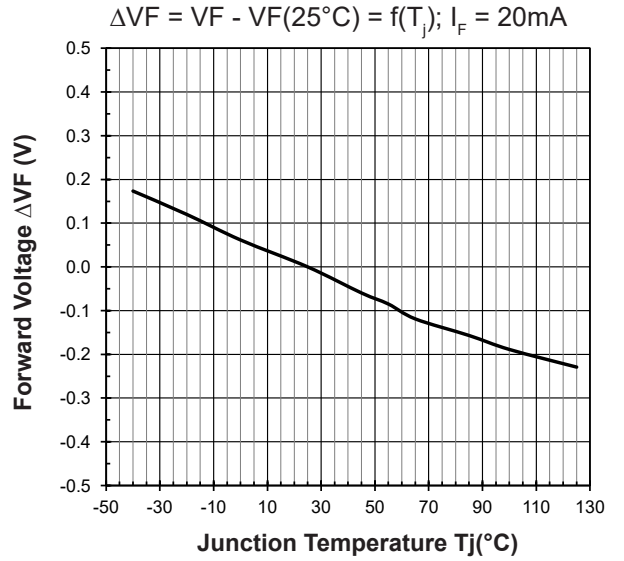

Relative Luminous Intensity Vs Junction Temperature

$I_V / I_V(25^\circ C) = f(T_j); I_V = 20mA$

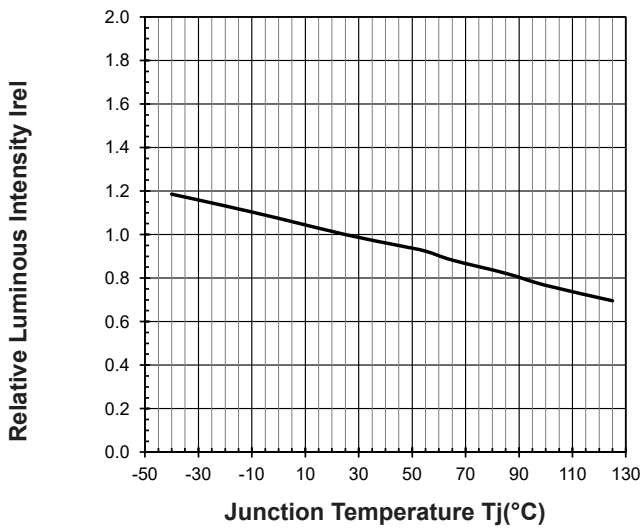

Chromaticity Coordinate Shift Vs Junction Temperature

$\Delta C_x, \Delta C_y = f(T_j); I_F = 20mA$

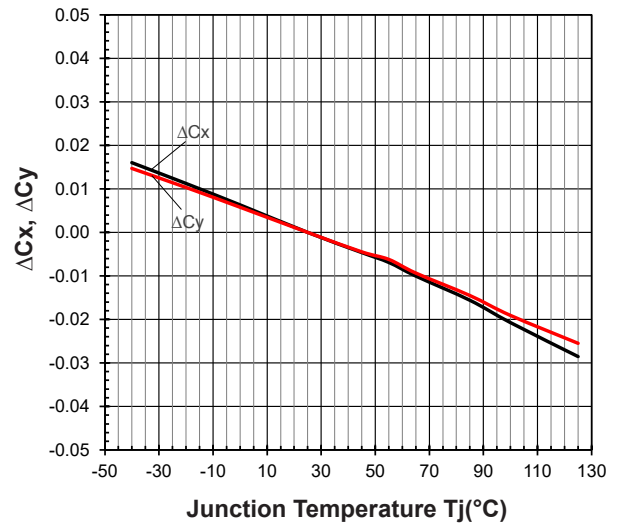

Mini DomiLED • InGaN : DNW-PJG-F1P5 Package Outlines

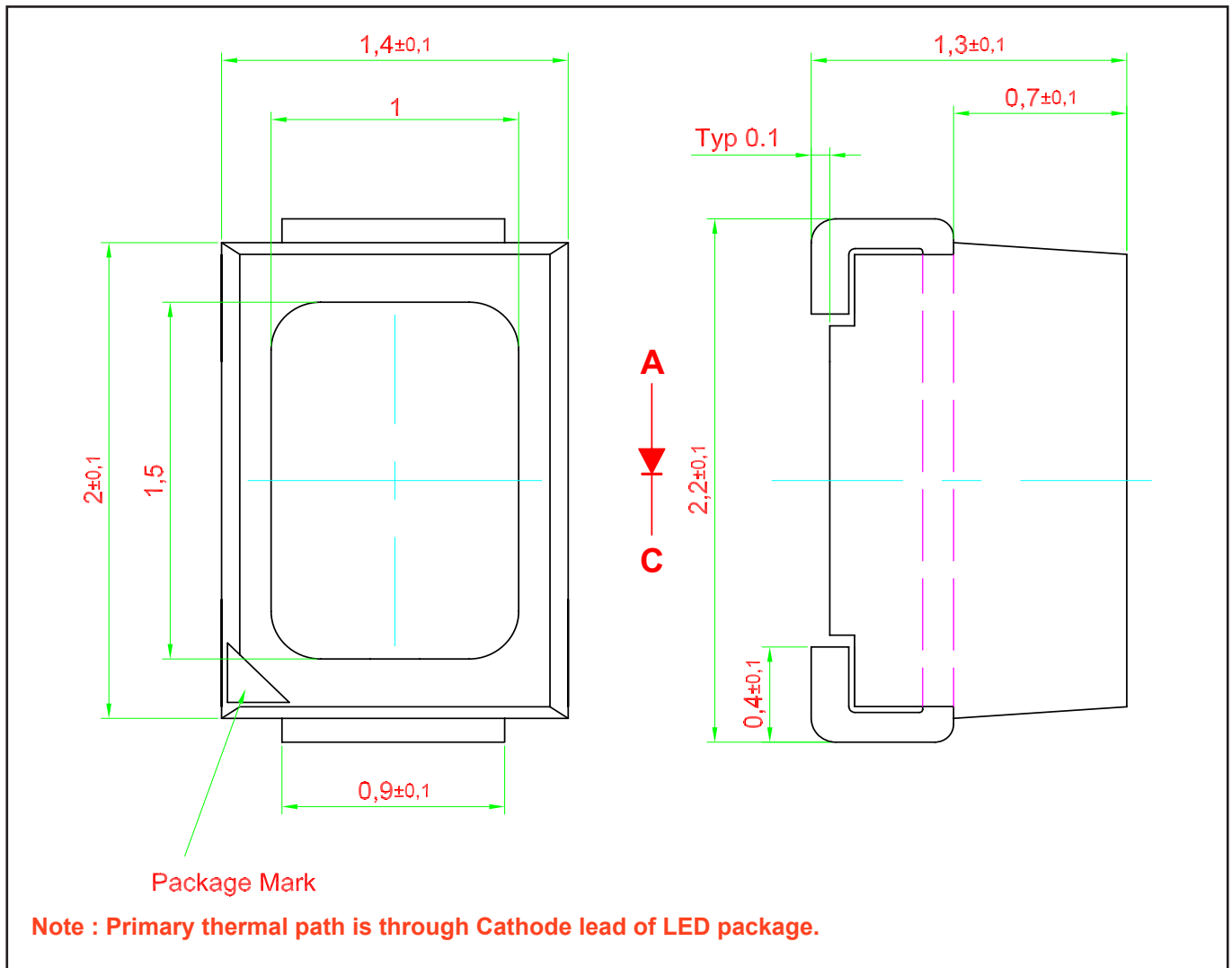

Material

Material	
Lead-frame	Cu Alloy With Ag Plating
Package	High Temperature Resistant Plastic
Encapsulant	Silicone Resin
Soldering Leads	Sn Plating

Recommended Solder Pad

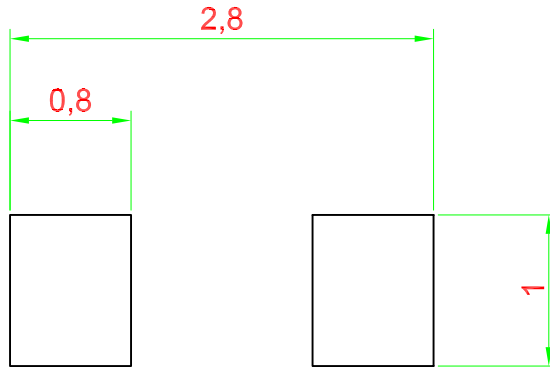

Improved Design For Better Heat Dissipation

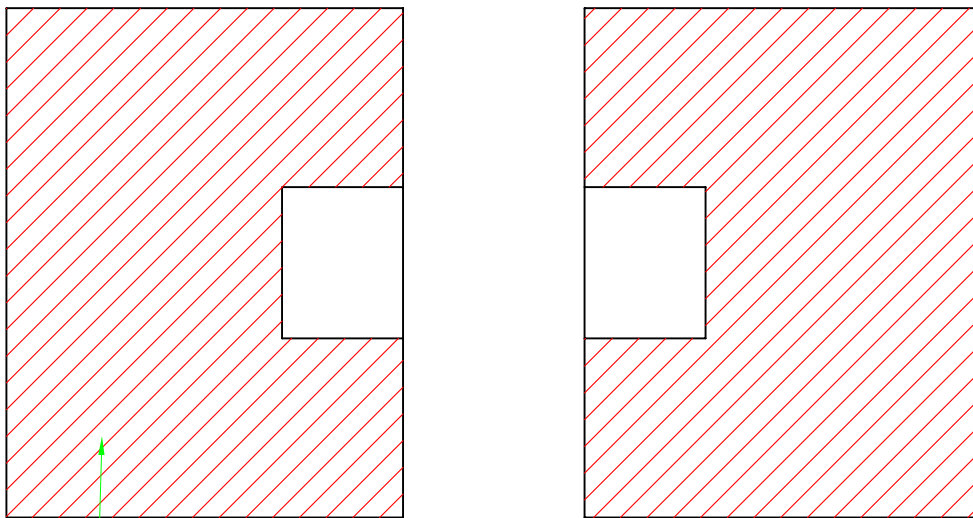

Additional Cu area for improved heat dissipation, > 16mm sq.

 Solder resist.

Taping and orientation

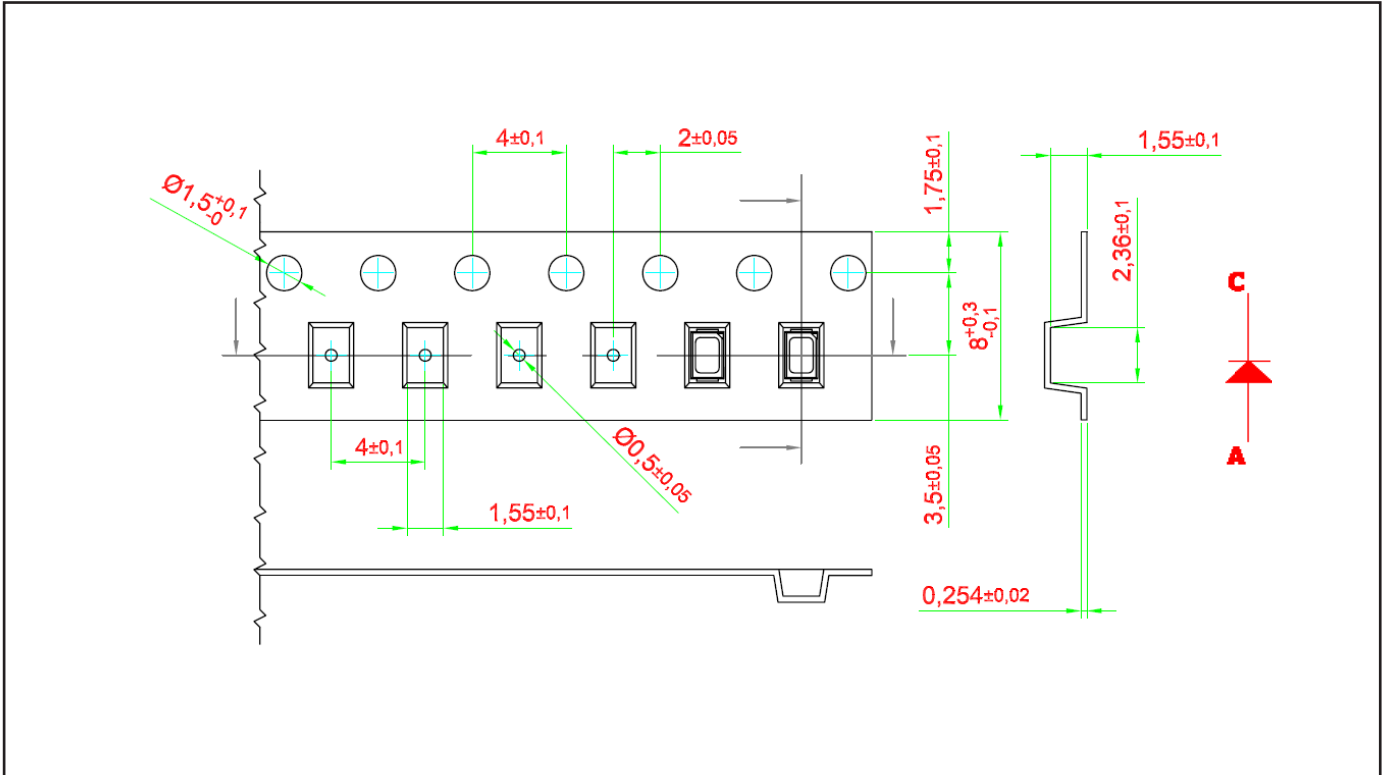

Packaging Specification

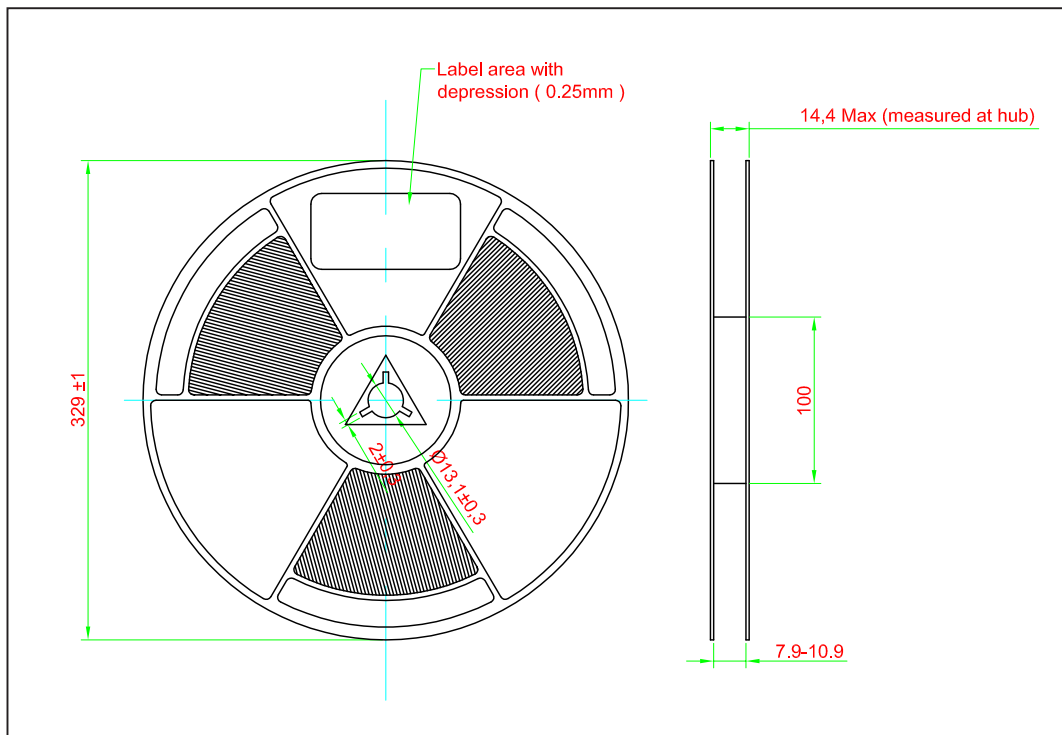
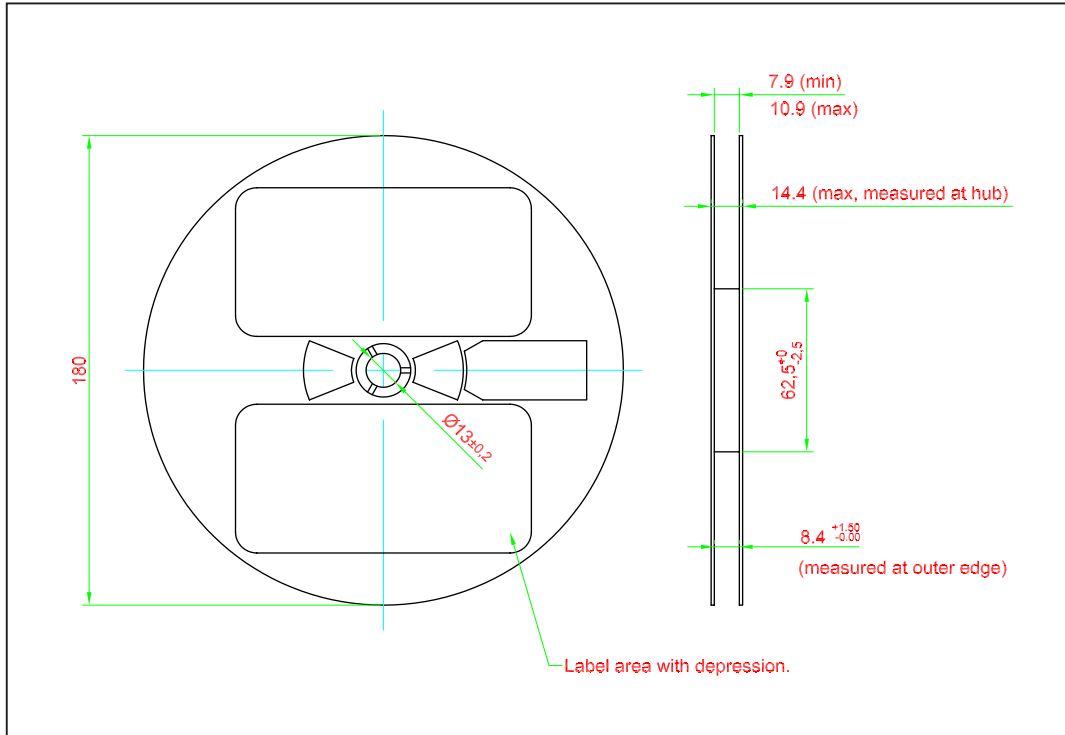

	Reel Diameter (mm)	Quantity (pcs)	*Ordering Number
Standard Packing	180	3000	DNW-PJG-xxx-xxxx
Optional Packing	329	10000	DNW-PJG-xxx-xxxx-J

Notes:

* For ordering purpose only. Please consult sales and marketing for details.

Packaging Specification

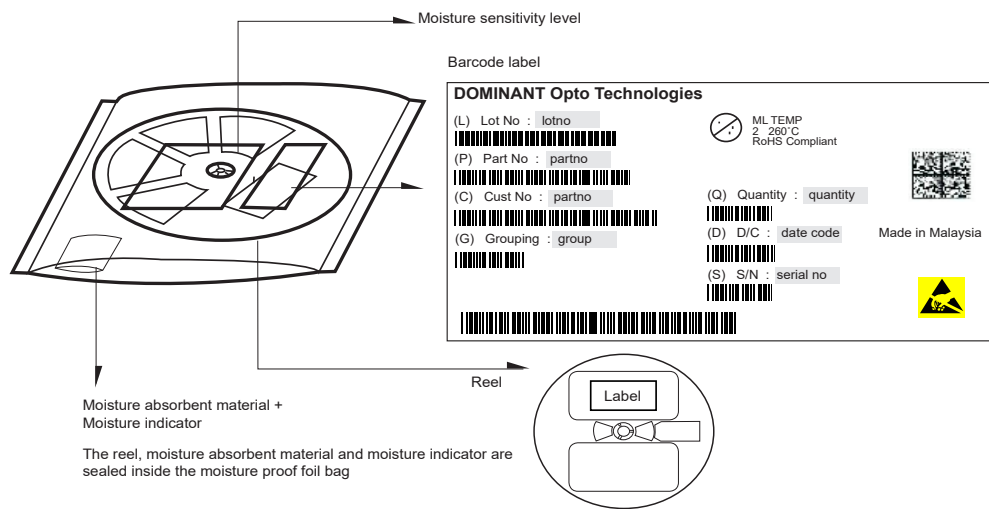

Quantity per bag (pcs)	Average 1pc Mini DomiLED (g)	1 completed bag (g)
3000	0.007	200 ± 10
10000	0.007	550 ± 10

Recommended Pb-free Soldering Profile

Product complies to MSL Level 2 acc. to JEDEC J-STD-020E

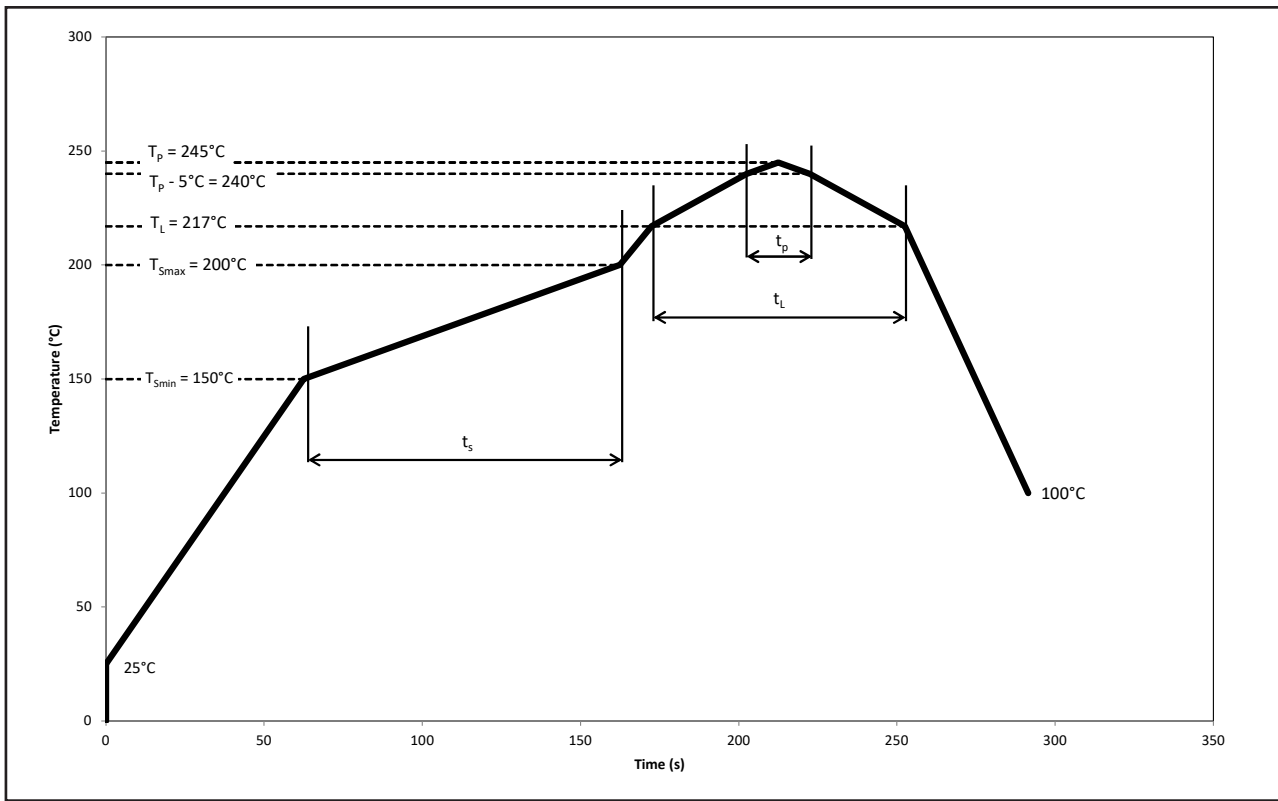

Profile Feature	Symbol	Pb-Free Assembly			Unit
		Min.	Recommended	Max.	
Ramp-up rate to preheat 25°C to T_{smin}	-	-	2	3	°C/s
Time t_s T_{smin} to T_{smax}	t_s	60	100	120	s
Ramp-up rate to peak T_L to T_p	-	-	2	3	°C/s
Liquidous temperature	T_L	-	217	-	°C
Time above liquidous temperature	t_L	60	80	150	s
Peak temperature	T_p	-	245	260	°C
Time within 5°C of the specified peak temperature $T_p - 5^\circ\text{C}$	t_p	10	20	30	s
Ramp-down rate T_p to 100°C	-	-	3	6	°C/s
Time 25°C to T_p	-	-	-	480	s

Appendix

1) **Brightness:**

- 1.1 Luminous intensity is measured at current pulse 25 ms(typ) with an internal reproducibility of $\pm 8 \%$ and an expanded uncertainty of $\pm 11 \%$ (according to GUM with a coverage factor of $k=3$).
- 1.2 Luminous flux is measured at current pulse 25 ms(typ) with an internal reproducibility of $\pm 8 \%$ and an expanded uncertainty of $\pm 11 \%$ (according to GUM with a coverage factor of $k=3$).
- 1.3 Radiant intensity is measured at current pulse 25 ms(typ) with an internal reproducibility of $\pm 8 \%$ and an expanded uncertainty of $\pm 11 \%$ (according to GUM with a coverage factor of $k=3$).
- 1.4 Radiant flux is measured at current pulse 25 ms(typ) with an internal reproducibility of $\pm 8 \%$ and an expanded uncertainty of $\pm 11 \%$ (according to GUM with a coverage factor of $k=3$).

2) **Color:**

- 2.1 Chromaticity coordinate groups are measured at current pulse 25 ms(typ) with an internal reproducibility of ± 0.005 and an expanded uncertainty of ± 0.01 (accordingly to GUM with a coverage factor of $k=3$).
- 2.2 Dominant wavelength is measured at current pulse 25 ms(typ) with an internal reproducibility of $\pm 0.5\text{nm}$ and an expanded uncertainty of $\pm 1\text{nm}$ (accordingly to GUM with a coverage factor of $k=3$).

3) **Voltage:**

- 3.1 Forward Voltage, V_f is measured when a current pulse of 8 ms(typ) with an internal reproducibility of $\pm 0.05\text{V}$ and an expanded uncertainty of $\pm 0.1\text{V}$ (accordingly to GUM with a coverage factor of $k=3$).

4) **Typical Values:**

- 4.1 At special conditions of LED manufacturing processes, typical data or calculated correlations of technical parameters only reflect the statistical figures. But not necessarily correspond to the actual parameters of each single product, which could differ from the typical data or calculated correlations or the typical characteristic line. These typical data may change whenever technical improvements happen.

5) **Tolerance of Measure**

- 5.1 Unless otherwise noted in drawing, tolerances are specified with ± 0.1 and dimension are specific in mm.

6) **Reverse Voltage:**

- 6.1 Not designed for reverse operation. Continuous reverse voltage can cause migration and LED damage.

7) **Corrosion Robustness:**

- 7.1 Test conditions: 40 °C / 90 % rh / 15 ppm H_2S / 336 h.
= Stricter than IEC 60068-2-43 (H_2S) [25 °C / 75% rh / 10 ppm H_2S / 21 days].

Revision History

Page	Subjects	Date of Modification
-	Initial Release	07 Sep 2015
3, 8	Remove Characteristics Update Graph	19 May 2016
2, 7, 9	Redefine Part Number from DNW-PJG-V2W-F1P5 into DNW-PJG-VW1-F1H5 DNW-PJG-V2W-I1L5 DNW-PJG-V2W-M1P5 Update Graph Add Notes in Package Outline	17 Jun 2016
1, 6, 15	Update Features Add Vf Binning (Optional) Add Appendix	08 Aug 2016
2	Not for New Design: DNW-PJG-VW1-F1H5 & DNW-PJG-V2W-M1P5 Add New Partno: DNW-PJG-V2W-F1H5 & DNW-PJG-WX1-M1P5	06 Feb 2017
12, 13, 14, 16	Update Packaging Specification Update Appendix	21 Feb 2020
1, 14	Update Features: AEC-Q101 to AEC-Q102 Update Recommended Pb-free Soldering Profile	05 Aug 2022
2, 14	Not for New Design: DNW-PJG-V2W-F1H5, DNW-PJG-V2W-I1L5, DNW-PJG-WX1-M1P5 Add New Part No: DNW-PJG-V2W-F1H3, DNW-PJG-V2W-I1L3, DNW-PJG-WX1-M1P3 Update Packaging Specification	25 Mar 2024

NOTE

All the information contained in this document is considered to be reliable at the time of publishing. However, DOMINANT Opto Technologies does not assume any liability arising out of the application or use of any product described herein.

DOMINANT Opto Technologies reserves the right to make changes to any products in order to improve reliability, function or design.

DOMINANT Opto Technologies products are not authorized for use as critical components in life support devices or systems without the express written approval from the Managing Director of DOMINANT Opto Technologies.

Dispose of product is in accordance with local, regional, national and international regulations.

About Us

DOMINANT Opto Technologies is a dynamic company that is amongst the world's leading automotive LED manufacturers. With an extensive industry experience and relentless pursuit of innovation, DOMINANT's state-of-art manufacturing and development capabilities have become a trusted and reliable brand across the globe. More information about DOMINANT Opto Technologies, an IATF 16949 and ISO 14001 certified company, can be found under <http://www.dominant-semi.com>.

Please contact us for more information:

DOMINANT Opto Technologies Sdn. Bhd
Lot 6, Batu Berendam, FTZ Phase III, 75350 Melaka, Malaysia.
Tel: +606 283 3566 Fax: +606 283 0566
E-mail: sales@dominant-semi.com
