

NagaJo

With continuous driven state of art mindset NagaJo is released to support today's market demand for new performance setting and economical standards. Its compact and robust in design, high efficiency, NagaJo also contributes to weight reduction. The small package outline with enhanced durability, enhanced heat dissipation and superior light performance.



Features:

- > Super high brightness surface mount LED automotive exterior applications.
- > 120° viewing angle.
- > Compact package outline (LxWxH) of 1.5 x 1.9 x 0.79mm.
- > Small LES 1.05 x 1.05mm.
- > Low thermal resistance, R_{thJS} ; 5.3K/W.
- > Superior corrosion robustness.
- > Compatible to IR reflow soldering.
- > Compliance to automotive standard; AEC-Q102.
- > Qualified according to JEDEC moisture sensitivity Level 2.
- > Environmental friendly; RoHS compliance.

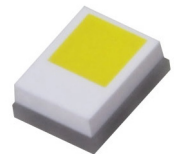

Applications:

- > Automotive: Exterior application: eg: Head Lamp - High Beam, Low Beam; Fog Lamp; DRL - Daytime Running Light.

Electrical Characteristics at Tj=25°C

Part	Color	Viewing Angle°	Luminous Flux @ 1A (lm) <i>Appx. 1.2</i>		
			Min.	Typ.	Max.
JKW-TZHY-9ZEB-VNBN	White	120	395.0	440.0	500.0
● JKW-TZHY-7ZEA-VNBN	White	120	347.0	410.0	450.0

● Not for new design

Electrical Characteristics at Tj=25°C

Part Number	Vf @ If = 1A <i>Appx. 3.1</i>		
	Min. (V)	Typ. (V)	Max. (V)
JKW-TZHY	2.90	3.25	3.50

Absolute Maximum Ratings

	Maximum Value	Unit
DC forward current	1.5	A
Peak pulse current; (Ts=55 °C, tp ≤ 100µs, Duty cycle = 0.03)	3	A
Reverse voltage; Ir _{max} = 10µA	Not for Reverse Bias	V
ESD threshold (HBM)	8	kV
LED junction temperature	150	°C
Operating temperature	-40 ... +125	°C
Storage temperature	-40 ... +125	°C
Thermal resistance (Rated current = 1A, Ts=25°C)		
- Real Thermal Resistance		
Junction / solder point, R _{th JS real} (typ = 5.3)	6.8	K/W
- Electrical Thermal Resistance		
Junction / solder point, R _{th JS el} (typ = 3.5)	4.5	K/W

Color Grouping *Appx. 2.1*

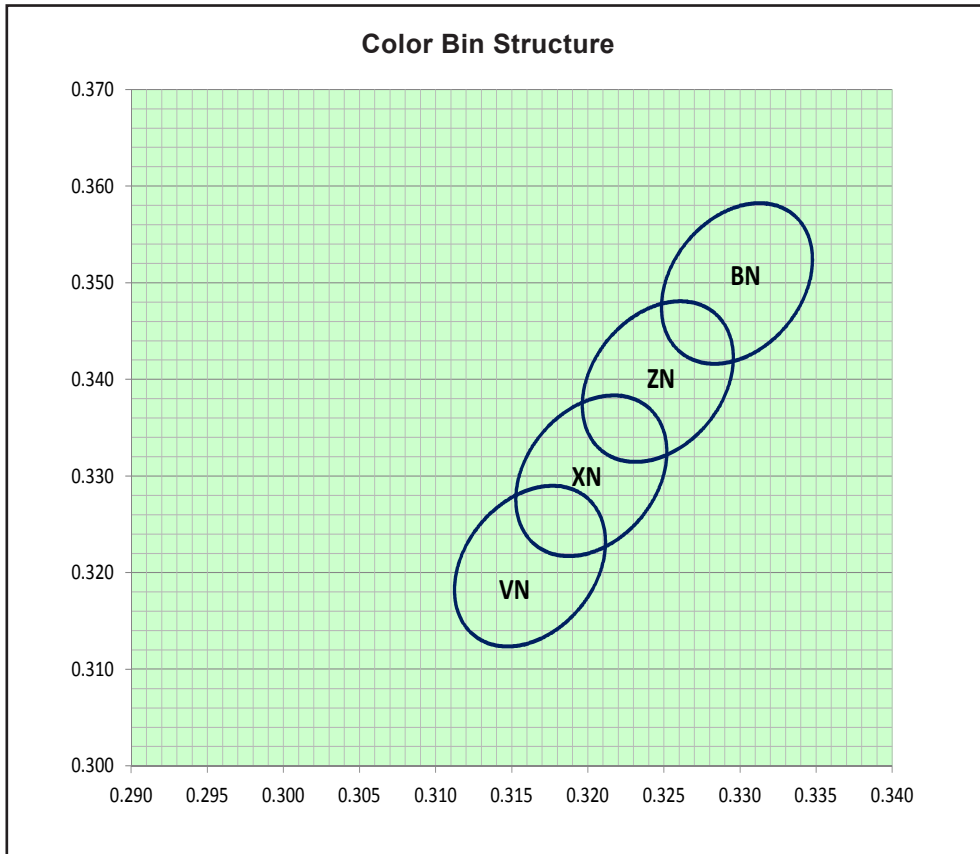

Bin	Ellipse	x	y	a	b	θ °
BN	5 Step	0.3298	0.3499	0.0085	0.00463	75.57
ZN	5 Step	0.3246	0.3398	0.0085	0.00463	75.57
XN	5 Step	0.3202	0.3300	0.0085	0.00463	75.57
VN	5 Step	0.3162	0.3207	0.0085	0.00463	75.57

InGaN wavelength is very sensitive to drive current. Operating at lower current is not recommended and may yield unpredictable performance current pulsing should be used for dimming purposed.

Luminous Flux Group at Tj=25°C

Brightness Group	Luminous Flux ^{Appx. 1.2} (lm)
7Z	347.0 ... 370.0
8Z	370.0 ... 395.0
9Z	395.0 ... 422.0
EA	422.0 ... 450.0
FA	450.0 ... 474.0
EB	474.0 ... 500.0

Vf Bining (Optional)

Vf Bin @ 1A	Forward Voltage (V) ^{Appx. 3.1}
VD8	2.90 ... 3.10
VD9	3.10 ... 3.30
VE1	3.30 ... 3.50

Please consult sales and marketing for special part number to incorporate Vf binning.

Relative Luminous Flux Vs Forward Current

$\Phi_V/\Phi_V(1A) = f(I_F); T_j = 25^\circ C$

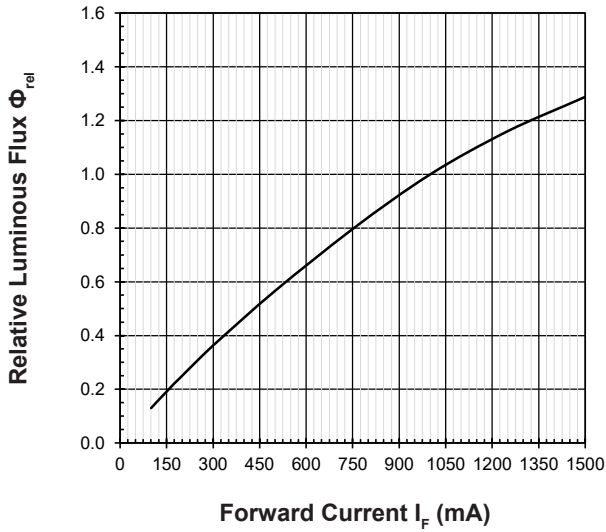

Forward Current Vs Forward Voltage

$I_F = f(V_F); T_j = 25^\circ C$

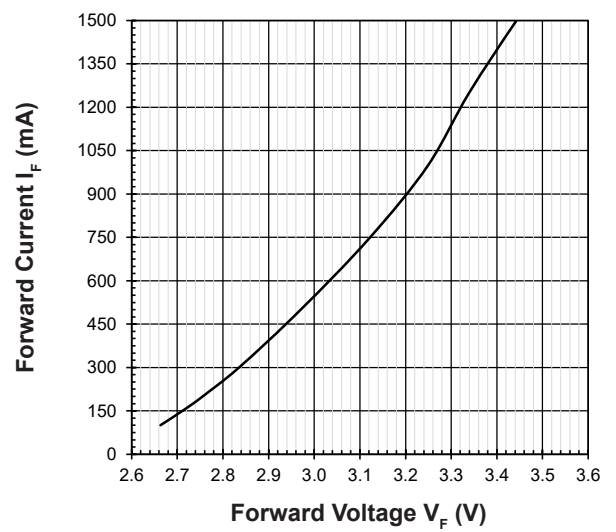

Maximum Current Vs Temperature

$I_F = f(T)$

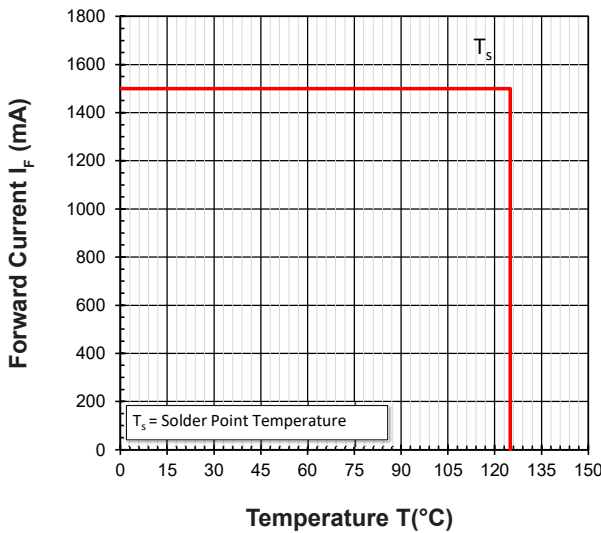

Relative Spectral Emission

$\Phi_{rel} = f(\lambda); T_j = 25^\circ C; I_F = 1A$

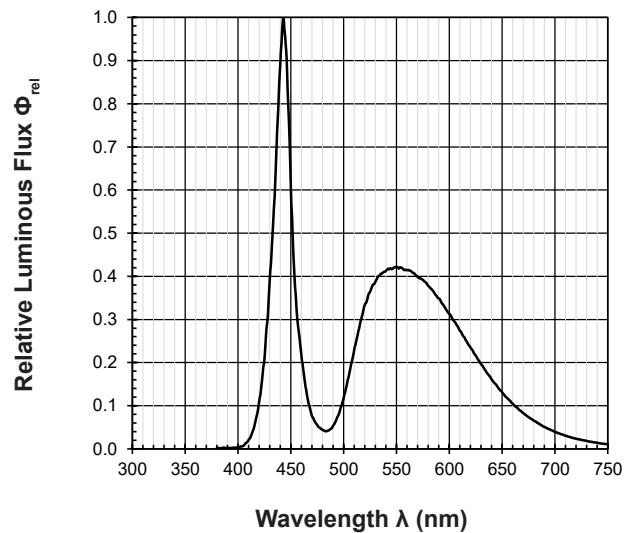

Chromaticity Coordinate Shift Vs Forward Current

$\Delta Cx, \Delta Cy = f(I_F); T_j = 25^\circ C$

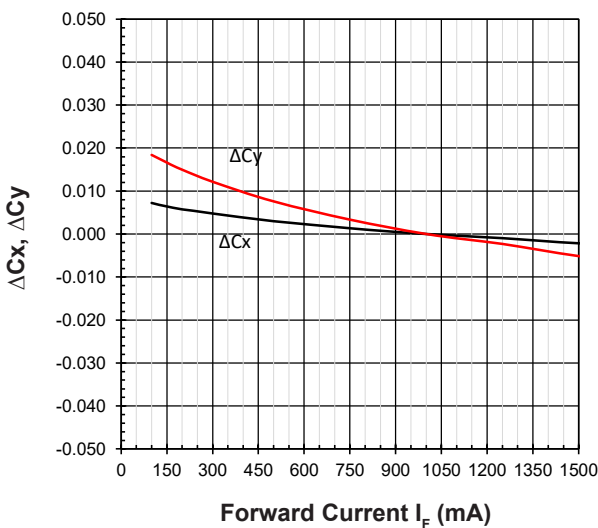

Allowable Forward Current Vs Duty Ratio

$(T_s = 55^\circ C; t_p \le 100\mu s)$

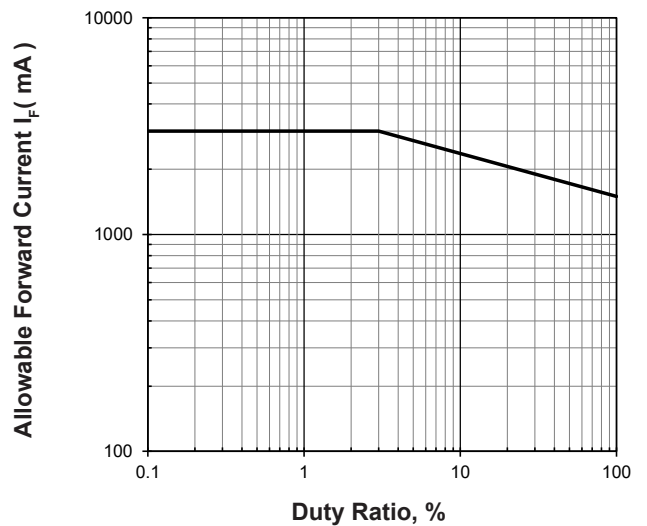

Radiation Pattern

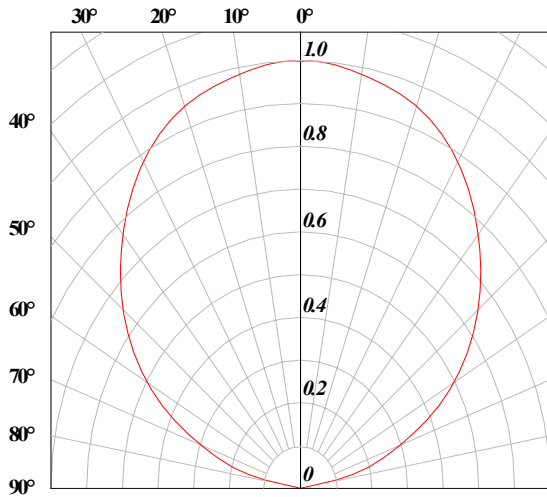

Forward Voltage Vs Junction Temperature

$$\Delta V_F = V_F - V_F(25^\circ\text{C}) = f(T_j); I_F = 1\text{A}$$

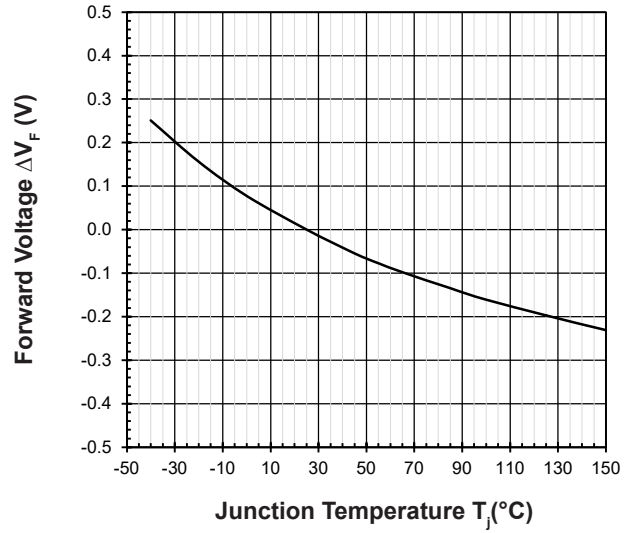

Relative Luminous Flux Vs Junction Temperature

$$\Phi_V/\Phi_V(25^\circ\text{C}) = f(T_j); I_F = 1\text{A}$$

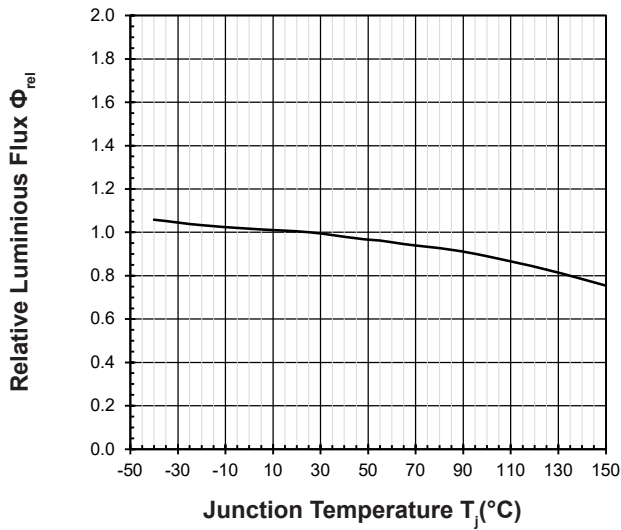

Chromaticity Coordinate Shift Vs Junction Temperature

$$\Delta C_x, \Delta C_y = f(T_j); I_F = 1\text{A}$$

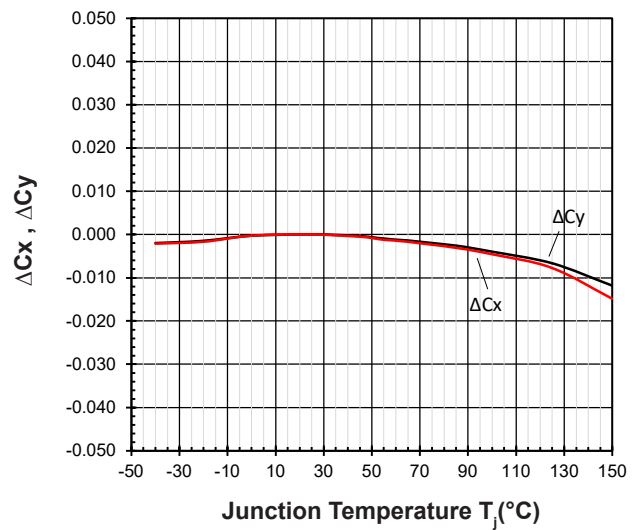

NagaJo 1519 InGaN : JKW-TZHY-VNBN Package Outlines

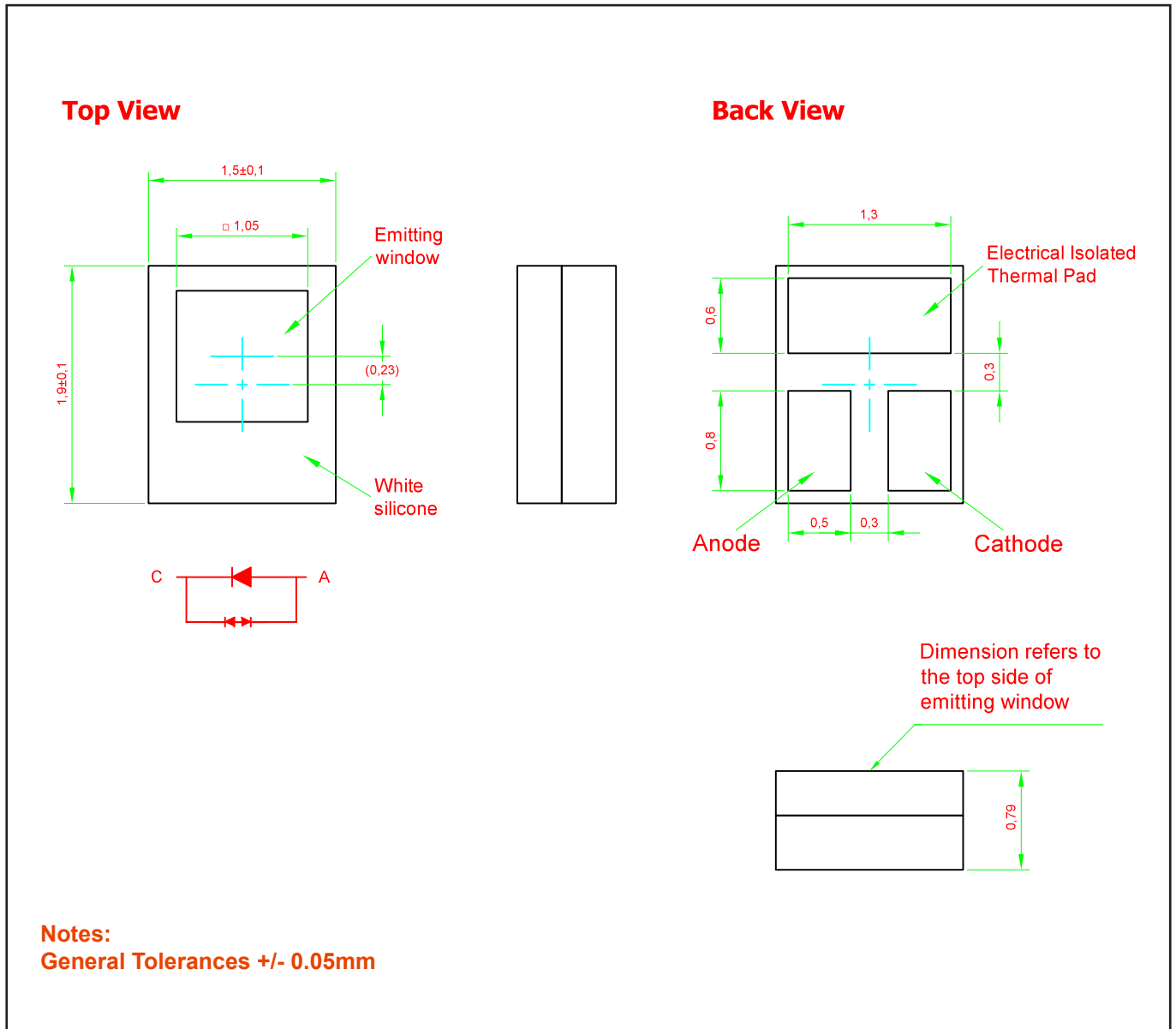

Material

	Material
Substrate	Ceramic
Encapsulant	Silicone Resin
Soldering Surface	Au Plating

Recommended Solder Pad

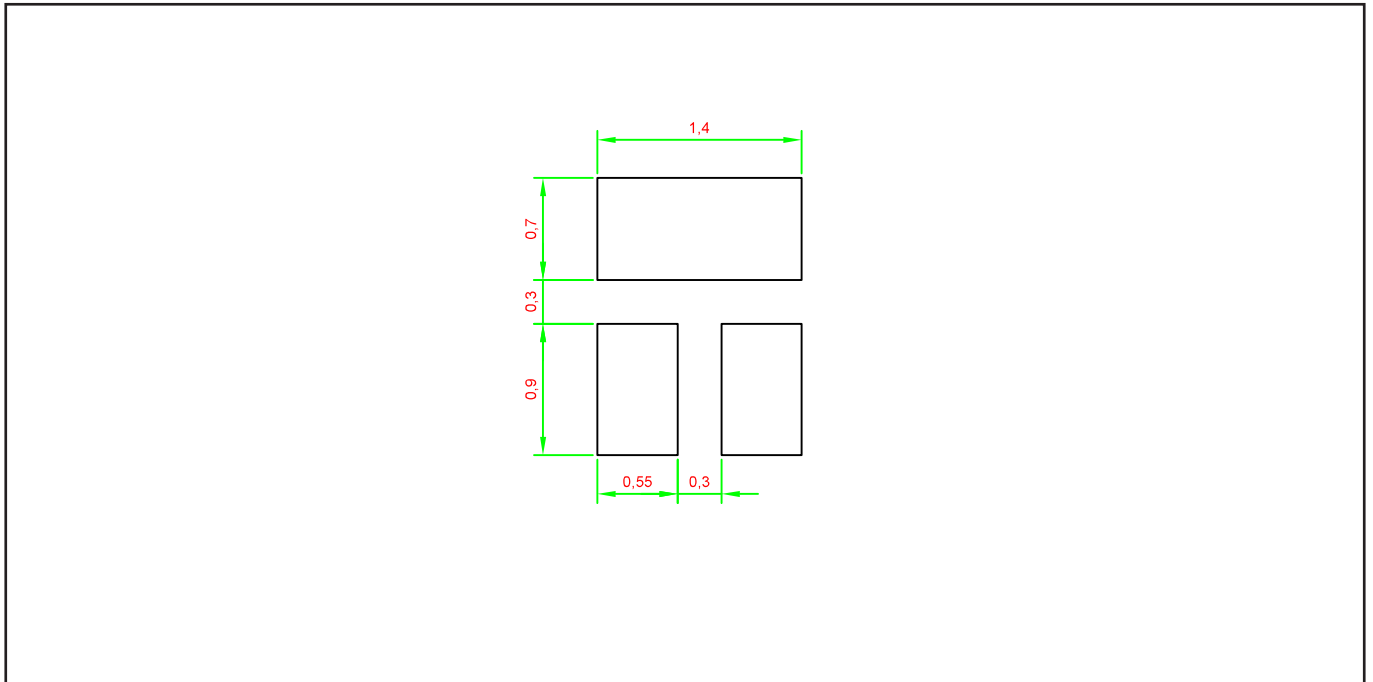

Recommended Solder Stencil Design

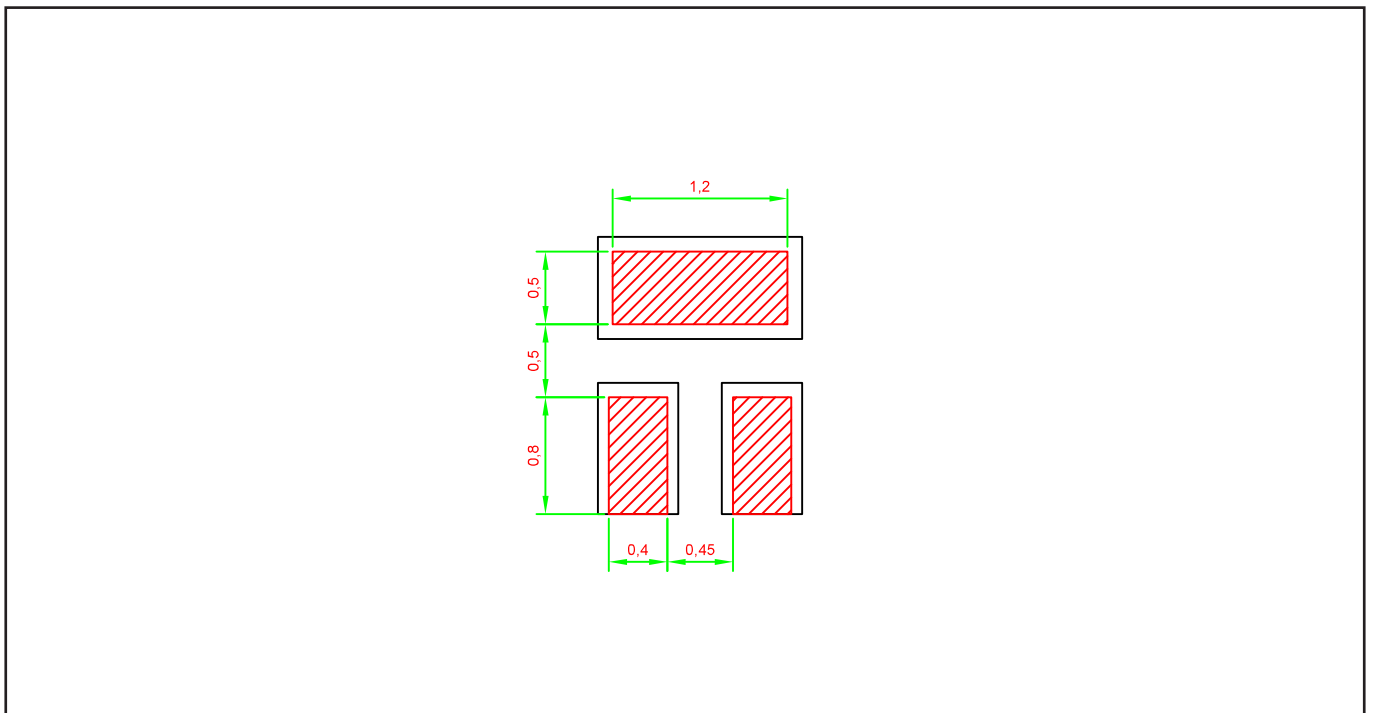

Taping and orientation

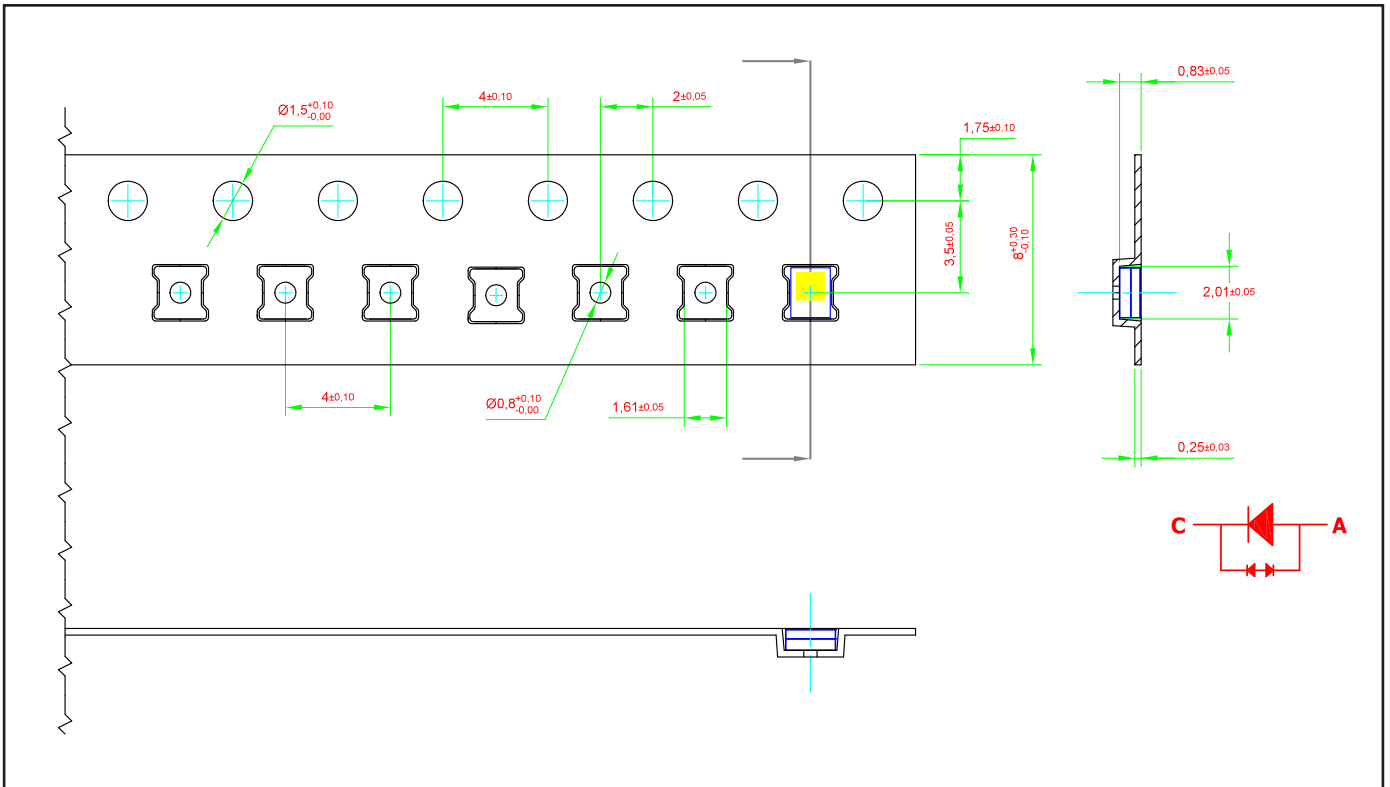

Notes:
 Please refer to DOMINANT LED Handling Procedure's application note for additional information.

Packaging Specification

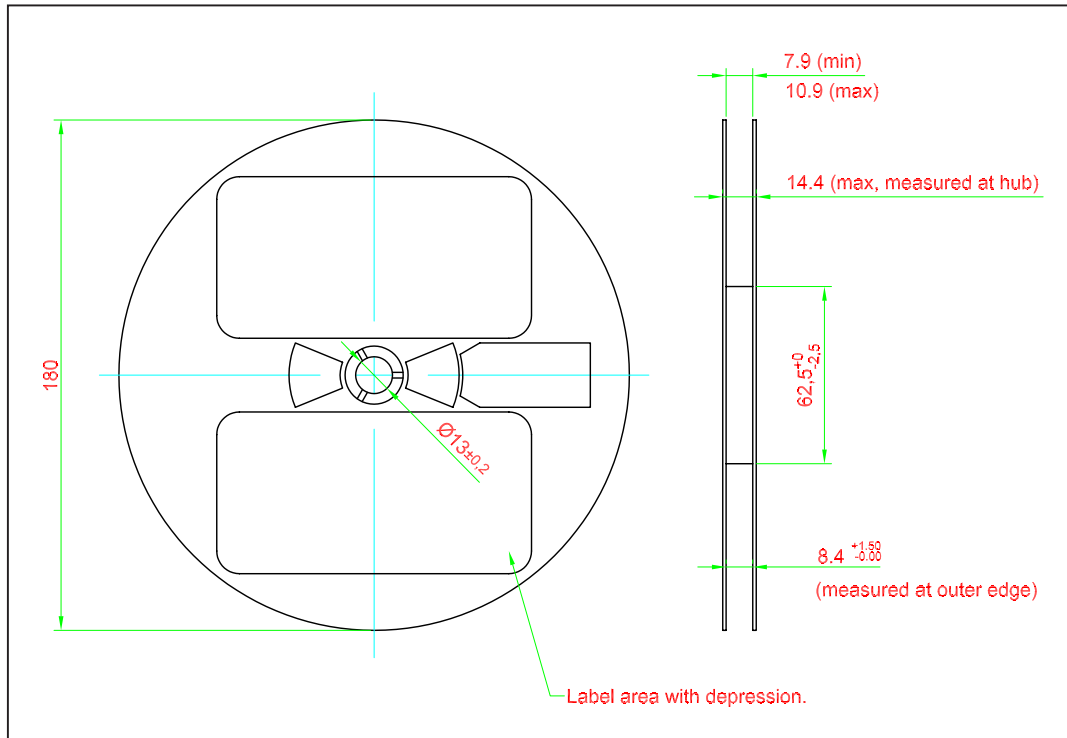

	Reel Diameter (mm)	Quantity (pcs)	*Ordering Number
Standard Packing	180	4500	JKW-TZHY-xxx-xxxx

Notes:

* For ordering purpose only. Please consult sales and marketing for details.

Packaging Specification

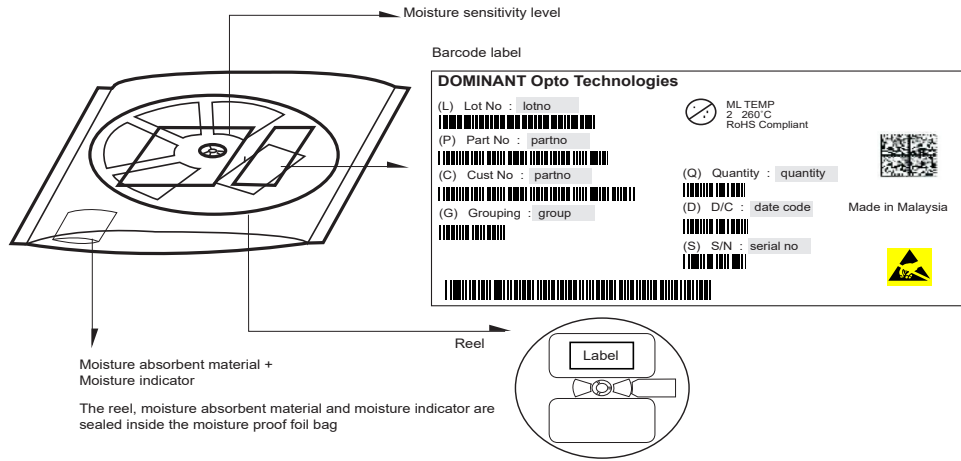

Quantity per bag (pcs)	Average 1pc NagaJo 1519 (g)	1 completed bag (g)
4500	0.0072	120 ± 10

Recommended Pb-free Soldering Profile

Product complies to MSL Level 2 acc. to JEDEC J-STD-020E

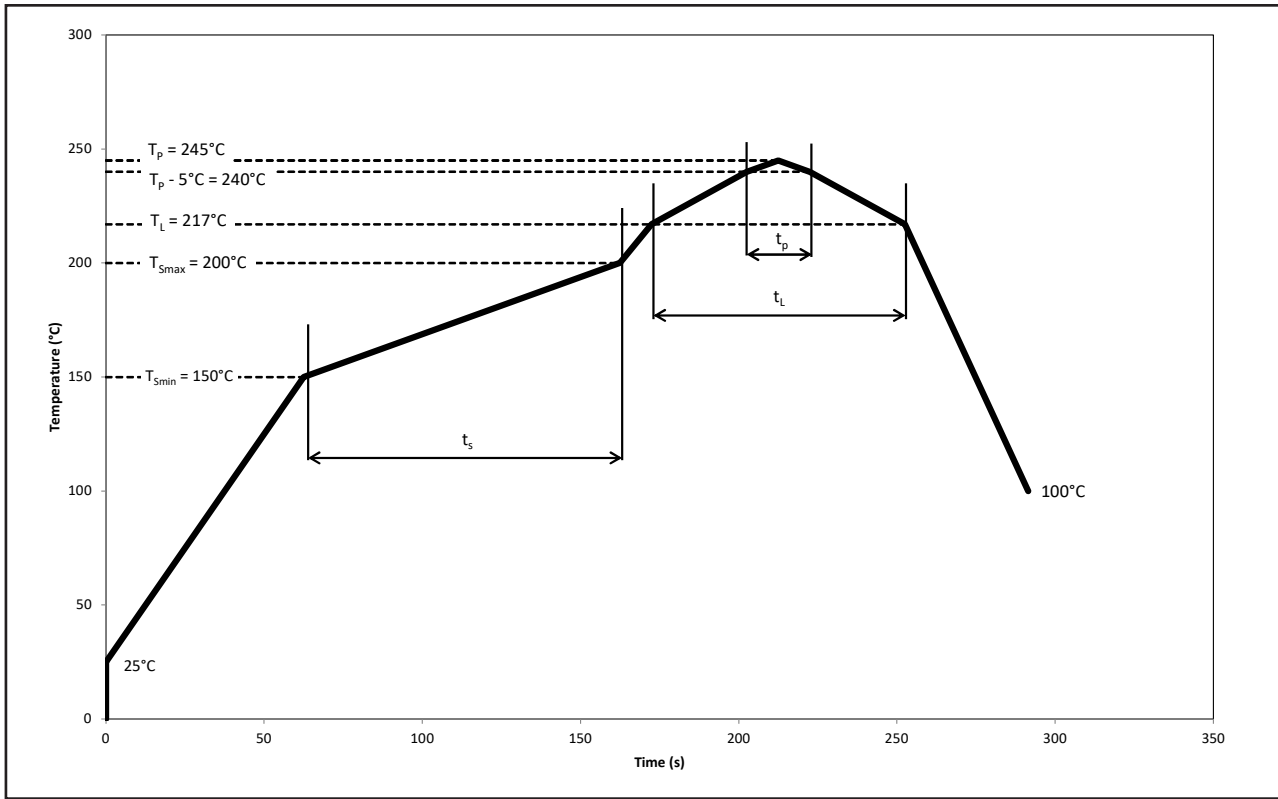

Profile Feature	Symbol	Pb-Free Assembly			Unit
		Min.	Recommended	Max.	
Ramp-up rate to preheat 25°C to T_{smin}	-	-	2	3	°C/s
Time t_s T_{smin} to T_{smax}	t_s	60	100	120	s
Ramp-up rate to peak T_L to T_p	-	-	2	3	°C/s
Liquidous temperature	T_L	-	217	-	°C
Time above liquidous temperature	t_L	60	80	150	s
Peak temperature	T_p	-	245	260	°C
Time within 5°C of the specified peak temperature $T_p - 5^\circ\text{C}$	t_p	10	20	30	s
Ramp-down rate T_p to 100°C	-	-	3	6	°C/s
Time 25°C to T_p	-	-	-	480	s

Appendix

1) **Brightness:**

- 1.1 Luminous intensity is measured at current pulse 1 ms(typ) with an internal reproducibility of $\pm 8\%$ and an expanded uncertainty of $\pm 11\%$ (according to GUM with a coverage factor of $k=3$).
- 1.2 Luminous flux is measured at current pulse 1 ms(typ) with an internal reproducibility of $\pm 8\%$ and an expanded uncertainty of $\pm 11\%$ (according to GUM with a coverage factor of $k=3$).
- 1.3 Radiant intensity is measured at current pulse 1 ms(typ) with an internal reproducibility of $\pm 8\%$ and an expanded uncertainty of $\pm 11\%$ (according to GUM with a coverage factor of $k=3$).
- 1.4 Radiant flux is measured at current pulse 1 ms(typ) with an internal reproducibility of $\pm 8\%$ and an expanded uncertainty of $\pm 11\%$ (according to GUM with a coverage factor of $k=3$).

2) **Color:**

- 2.1 Chromaticity coordinate groups are measured at current pulse 1 ms(typ) with an internal reproducibility of ± 0.005 and an expanded uncertainty of ± 0.01 (accordingly to GUM with a coverage factor of $k=3$).
- 2.2 Dominant wavelength is measured at current pulse 1 ms(typ) with an internal reproducibility of $\pm 0.5\text{nm}$ and an expanded uncertainty of $\pm 1\text{nm}$ (accordingly to GUM with a coverage factor of $k=3$).

3) **Voltage:**

- 3.1 Forward Voltage, V_f is measured when a current pulse of 8 ms(typ) with an internal reproducibility of $\pm 0.05\text{V}$ and an expanded uncertainty of $\pm 0.1\text{V}$ (accordingly to GUM with a coverage factor of $k=3$).

4) **Typical Values:**

- 4.1 At special conditions of LED manufacturing processes, typical data or calculated correlations of technical parameters only reflect the statistical figures. But not necessarily correspond to the actual parameters of each single product, which could differ from the typical data or calculated correlations or the typical characteristic line. These typical data may change whenever technical improvements happen.

5) **Tolerance of Measure**

- 5.1 In the drawing, normally the tolerances used are at ± 0.1 with the dimension measurement unit in mm.

Revision History

Page	Subjects	Date of Modification
-	Initial Release	04 Apr 2023
2, 6	Update Typ Flux Update Graph	08 Jun 2023
7	Add Info in Package Outline	12 Sep 2023
2, 11	Add New Part No: JKW-TZHY-9ZEB-VNBN Not for New Design: JKW-TZHY-7ZEA-VNBN Update Packaging Specification	14 Mar 2024

NOTE

All the information contained in this document is considered to be reliable at the time of publishing. However, DOMINANT Opto Technologies does not assume any liability arising out of the application or use of any product described herein.

DOMINANT Opto Technologies reserves the right to make changes to any products in order to improve reliability, function or design.

DOMINANT Opto Technologies products are not authorized for use as critical components in life support devices or systems without the express written approval from the Managing Director of DOMINANT Opto Technologies.

Dispose of product is in accordance with local, regional, national and international regulations.

About Us

DOMINANT Opto Technologies is a dynamic company that is amongst the world's leading automotive LED manufacturers. With an extensive industry experience and relentless pursuit of innovation, DOMINANT's state-of-art manufacturing and development capabilities have become a trusted and reliable brand across the globe. More information about DOMINANT Opto Technologies, an IATF 16949 and ISO 14001 certified company, can be found under <http://www.dominant-semi.com>.

Please contact us for more information:

DOMINANT Opto Technologies Sdn. Bhd.
Lot 6, Batu Berendam, FTZ Phase III, 75350 Melaka, Malaysia
Tel: (606) 283 3566 Fax: (606) 283 0566
E-mail: sales@dominant-semi.com
